

USER MANUAL

(1.1 version)

AUTO HEMATOLOGY ANALYZER TEK8520



DRAWELL
Artist of Science

Please read operating manual before installation and operation.

Drawell International Technology Limited
Chongqing Drawell Instrument Co., Ltd.
Shanghai Drawell Scientific Instrument Co.,Ltd.

Add : Suite 2705, Building No.12, Shiyou Road No.1, Yuzhong , Chongqing

Homepage : www.drawell.com.cn

Tel : 0086-023-63268643

Email : sales05@drawell.com.cn

Product Guarantee

Guarantee period: One year after the installation date.

Guarantee content: DRAWELL will supply free amendment to customers due to the trouble caused by fault of our design, manufacturing during the guarantee period, but DRAWELL will take relative action as amend method according to the trouble content.

Non-guarantee Items (Non responsibility Items): If the following situation occurs, it is not including in the guarantee rang even within guarantee period:

- The trouble caused by used instrument out of using environment mentioned in this Illumination.
- The trouble caused by wild operation, using by mistake, operation by mistake.
- The trouble caused by removing, transporting, installation procedure and means which not permitted by our company.
- The trouble caused by self disassembly or reassembly instrument.
- The trouble caused by fire, earthquake, wind harm, flood, lighting strike, crime, terrorism, war and other irresistible natural disasters.
- The trouble caused by improper maintenance or maintaining companies which are not pointed by DRAWELL.
- The trouble caused by not placing the consumables or spare parts that have life period in time.
- The trouble caused by using hardware, software or assistant products not supplied by DRAWELL.
- Circuit corrosion, optics component aging in evidence by strong corrosive gas in the air.
- The trouble caused by using condemned instrument or buy secondhand instrument without connecting with DRAWELL.

WARNING

- It is important for the hospital or organization that employs this equipment to carry out a reasonable service/maintenance plan. Neglect of this may result in machine breakdown or person injury.
- Be sure to operate the analyzer under the situation specified in this manual, otherwise the analyzer will not work normally and the analysis results will be unreliable, which would damage the analyzer components and cause personal injury.

CAUTION

- This equipment must be operated by skilled/trained clinical professionals.
-

Table of contents

Chapter 1	Using this manual	1
1.1	Introduction	1
1.2	Who should read this manual	2
1.3	How to find information	3
1.4	Conventions used in this manual	4
1.5	Safety Information	5
1.6	When you see	7
Chapter 2	Understanding the analyzer.....	13
2.1	Introduction	13
2.2	Parameters	14
2.3	Product description	15
2.3.1	Main unit	15
2.3.2	Power/status light	15
2.3.3	Power switch	15
2.3.4	【Start】 Key	16
2.3.5	Network port	16
2.4	Operation interface	17
2.5	Software operation	20
2.5.1	Touch screen location	20
2.5.2	Prime reagents	20
2.5.3	Background test	21
2.5.4	sample test	21
2.5.5	Historical data query and statistics	21
2.5.6	Calibration	21
2.5.7	QC	21
2.5.8	Maintanance	22
2.5.9	Log query	22
2.5.10	Setup	22
2.5.11	Windows	22
2.5.12	Explanation	22
2.6	Report setup and print	23
2.6.1	Report setup	23
2.6.2	Print	23
2.7	Reagents, QC and Calibration	24
2.7.1	Reagents	24
2.7.2	QC and calibration	24

Chapter 3	System principles.....	25
3.1	Introduction.....	25
3.2	Mode	25
3.2.1	whole blood mode	25
3.2.2	Predilution mode	25
3.2.3	Blank mode	25
3.2.4	Whole blood-CBC mode	25
3.2.5	Whole blood-WBC mode	25
3.2.6	Whole blood-RBC mode	25
3.2.7	Whole blood-HB mode	26
3.3	WBC Measurement	26
3.3.1	Laser flow cytometry technique	26
3.3.2	Impedence method principle	27
3.3.3	WBC parameter	27
3.4	HGB Measurement	28
3.4.1	Colorimetric method	28
3.4.2	HGB concentration parameters	29
3.5	RBC/PLT Measurement	29
3.5.1	Impedence	29
3.5.2	RBC parameter	29
3.5.3	PLT parameter	30
3.6	Rinse.....	30
Chapter 4	Installation.....	31
4.1	Introduction.....	31
4.2	Installation Requirement	32
4.2.1	Space	32
4.2.2	Power	32
4.2.3	General Environment	32
4.2.4	Moving and installing the analyzer	33
4.3	Connecting the analyzer system.....	34
Chapter 5	Setup.....	35
5.1	Introduction.....	35
5.2	General manage level	35
5.2.1	Setup	35
Chapter 6	Operating analyzer.....	38
6.1	Introduction.....	38
6.2	Initial Checks.....	39
6.3	Startup and logon.....	41
6.4	Daily Quality Control.....	42

CONTENTS

6.5	Sample preparation	42
6.5.1	Whole blood sample	43
6.5.2	Pre-diluted sample	43
6.6	Sample analysis step	45
6.7	Entry work sheet informaiton	47
6.8	Analysis result treatment	51
6.9	Shut down	55
Chapter 7	Reviewing Sample Results.....	56
7.1	Introduction	56
7.2	Image review	57
7.2.1	Sample/patient information	58
7.3	List review	58
7.4	Bulk print archive list	59
7.5	Output file	60
7.6	Input file	60
Chapter 8	QC	62
8.1	Introduction	62
8.2	L-J QC	62
8.2.1	Editing QC	62
8.2.2	QC Analysis	63
8.2.3	QC result review	66
8.3	Floating mean value	69
8.3.1	Edit QC	69
Chapter 9	Calibrating the analyzer.....	72
9.1	Introduction	72
9.2	When to calibrate	73
9.3	How to calibrate	74
9.3.1	Preparation	74
9.3.2	Manual Calibration	77
9.3.3	Auto Calibration	78
9.3.4	Calibration review	79
Chapter 10	Service.....	80
	Introduction	80
10.1	Maintaining	81
10.2	10.2.1 Change reagents	81
	10.2.2 Counter cleaning	84
	10.2.3 Aperture cleaning	85
	10.2.4 Evacuation	86
	Daily query	87
10.3	10.3.1 Alarm	87

CONTENTS

10.3.2	Reagent	87
10.3.3	Maintanance	88
10.3.4	Daily operation	88
Chapter11	Troubleshooting.....	89
11.1	Introduction	89
11.2	Error information and handling	89
Chapter12	Report format edit.....	90
12.1	Introduction	90
12.2	Edit print sampler	91
Appendix A Licence for manufacture measuring instrument.....		92
Appendix B Specifications.....		93
B.1	Classification	93
B.2	Reagents	93
B.3	Parameters	93
B.4	Sampling Features	95
B.4.1	Sample volumes required for each analysis	95
B.4.2	Throughput	95
B.5	Performance specifications	96
B.5.1	Display range	96
B.5.2	Background/Blank range	96
B.5.3	Linearity Range	96
B.5.4	Repeatability index	96
B.5.5	Carryover	97
B.6	Input/Output Device	97
B.6.1	Keyboard Mouse	98
B.6.2	External Bar code scanner(Optional)	98
B.6.3	Printer(Optional)	98
B.7	Interfaces	98
B.8	Power Supply	98
B.9	Sound	98
B.10	Operating Enviroment	98
B.11	Storage Enviroment	98
B.12	Running Eniroment	99
B.13	Dimensions and Weight	99
B.14	Contraindications	99
Appendix CCommunication.....		100
C.1	Auto hematology analyzer communication protocol instruction	100
C.1.1	HL7 interface protocol supporting message	102
C.1.2	Underlying transport protocal	102

CONTENTS

C. 1.3 HL7 message protocol	103
C.2 HL7 introduction	105
C.2. 1 HL7 basic syntax	105
C.2.2 HL7 data type	106
C.3 Two way communication	107
C.3. 1 Supporting HL7 message	107
C.3.2 Definition of related to HL7	108
C.3.3 Complete message demonstration	117
C.4 Appendix Definition by HL7 data type	124
C.5 Appendix:Message encoding definition	127
C.6 Appendix:Base64 code prodedure	139
Appendix D Toxic and Hazardous Substances and Elements Content Table.....	214
Backpage	714





Charper1 Using This Manual

1.1 Introduction

This chapter explains how to use your TEK8520 operator's manual, which is shipped with your TEK8520 AUTO HAMATOLOGY ANALLYZER and contains reference information about the analyzer and procedures for operating, troubleshooting and maintaining the analyzer. Read this manual carefully before operating your TEK8520 analyzer and operate your TEK8520 analyzer strictly as instructed in this manual.

1.2 Who should read this manual

This manual is intended to be read by clinical laboratory professionals. This equipment must only be operated by skilled/trained clinical professionals. This information contains information for clinical laboratory professionals to:

-  Learn about the TEK8520 hardware and software.
-  Customize system settings.
-  Perform daily operating tasks.
-  Perform system maintenance and troubleshooting.

1.3 How to find information

This operator's manual comprises 12 chapters and 4 appendices. Refer to the table below to find the information you need.

If you want to...	See...
Learn about the intended use and parameters of the TEK8520	Chapter2 Understanding Analyzer
Learn about the hardware,interface and software of TEK8520	Chapter2 Understanding Analyzer
Learn about how the TEK8520 works	Chapter3 system principles
Learn about the installation requirement of the TEK8520	Chapter 4 Installation
Learn about setup of date formal,parameter unit and etc.	Chapter 5 Setup
Learn about the process of sample collection and analysis	Chapter6 Operating your analyzer
Learn about how to use the TEK8520 to perform daily	Chapter6 Operating analyzer
Review sample results	Chapter7 Reviewing sample results
Learn about how to use the quality control programs of the TEK8520	Chapter8 QC
Learn about how to calibrate the TEK8520	Chapter9 Calibrating analyzer
Learn about how to define/adjust system settings	Chapter 10 Service
Learn about how to solve the problems of the TEK8520	Chapter11 Troubleshooting
Learn about customizing method of print format for TEK8520	Chapter 12 Report format edit
Learn about the specification pointer of TEK8520	Appendix B Specifications
Learn about communication protocol of TEK8520	Appendix C Communication
Learn about Toxic and Hazardous Substances and Elements Content Table	Appendix D Toxic and Hazardous Substances and Elements Content Table

1.4 Conventions used in this manual





This manual uses certain typographical conventions to clarify meaning in the text:

Format	Indication
[××]	All capital letters enclosed in[] indicate a key name on the analyzer or external keyboard, such as [ENTER]
—××	Bold letters included in— indicate text you may find on the screen of TEK8520 ,such as —Clean
××	bold letters indicate chapter titles, such as Chapter1 Using this manual

All illustrations in this manual are provided as examples only. They may not necessarily reflect setup of the TEK8520 or data displayed.

1.5 Safety Information

The following symbols are used to indicate danger and alert information in this manual.

When you see	Meaning
	Read the statement below the symbols. The statement is alerting you to a potentially biohazardous condition.
	Read the statement below the symbol. The statement is alerting you to an operating hazard that can cause personnel injury.
	Read the statement below the symbol. The statement is alerting you to a possibility of analyzer damage or unreliable analysis results.
	Read the statement below the symbol. The statement is alerting you to information that requires your attention.



- All the samples, control, calibrators, reagents, wastes and areas contacted them are potentially biohazardous. Wear proper personal protective equipment (e.g. gloves, lab coat, etc.) and follow safe laboratory procedures when handling them and the contacted areas in the laboratory.
- If a leak happens to the analyzer, the leak liquid is potentially biohazardous.







- Please check the firmness of all the doors and covers before running the analyzer.
- Make sure all the safety measurements are adopted. Disable any safety device or sensor is prohibited.
- Please take action to any alarm and problem indication immediately.
- Do not touch the moving parts.
- Contact DRAWELL or DRAWELL-authorized distributors in time if any damaged part is found.
- Be careful when opening /closing and removing/installing the doors, covers and boards of the analyzer.
- Discard the analyzer according to government regulations.

CAUTION





- Please use the analyzer strictly according to this manual.
- Please adopt proper measurements to prevent the reagents from being polluted.
- Use the reagents specified by the manufacturer only. Store and use the reagents as instructed by instructions for use of the reagents.
- Check if the reagent tubes are properly connected before using the analyzer.

1.6 When you see...

You will find the following symbols in this manual:

When you see	Meaning
	Read the statement below the symbols. The statement is alerting you to a potentially biohazardous condition.
	Read the statement below the symbol. The statement is alerting you to an operating hazard that can cause personnel injury.
	Read the statement below the symbol. The statement is alerting you to a possibility of analyzer damage or unreliable analysis results.
	Read the statement below the symbol. The statement is alerting you to information that requires your attention.

You may find the following symbols of the analyzer system:

When you see...	Meaning
	CAUTION, CONSULT ACCOMPANYING
	BIOLOGICAL RISK
	WARNING, LASER BEAM
	EXERCISE CAUTION WHEN WORKING AROUND TO AVOID PRICKING













	PROTECTIVE EARTH(GROUND)
	ALTERNATING CURRENT
	FOR IN VITRO DIAGNOSTIC USE
	BATCH CODE
	USE BY
	SERIAL NUMBER
	The measurement mark
	DATE OF MANUFACTURE
	MANUFACTURE
	TEMPERATURE LIMITATION
	The electronic products contain some toxic and harmful substances, In the environmental protection use period of 20 years can be assured use, After used more than 20 years should enter the recycling system.
	Handling tips
	The device fully comply with EU directive 98/79/EC requirements for in vitro diagnostic equipment
	CONSULT THE OPERATOR'S MANUAL

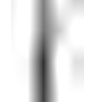

Figure1- 1 Back of the analyzer

⚠ WARNING

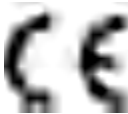
- Connect only to a properly earth grounded outlet
 - To avoid electric shock,disconnect power cord prior to removing or replacing fuse.
 - Replace fuse only with the type and rating specified.
-

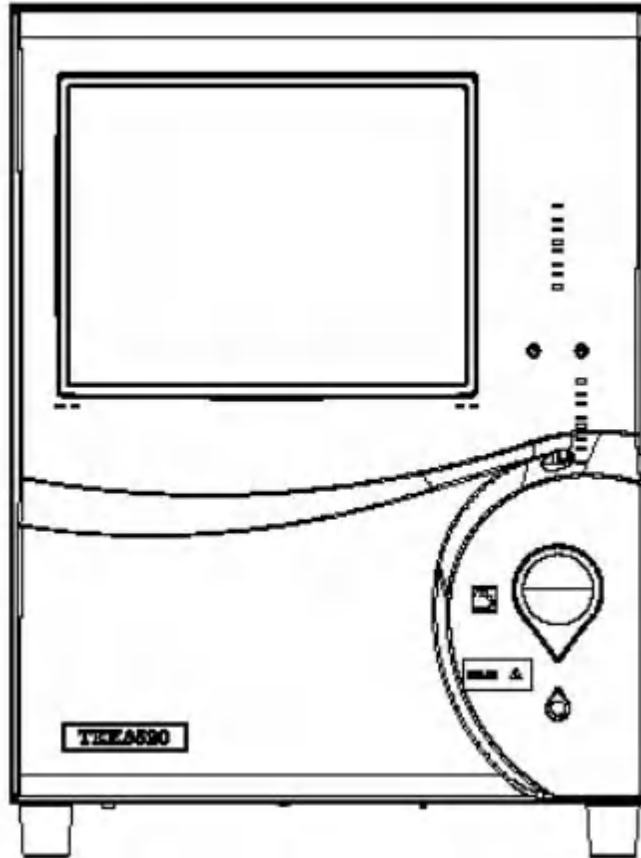

Figure 1-2 Front of the analyzer

CAUTION

- The sample probe is sharp and potentially biohazardous. Exercise caution to avoid contact with the probe when working around it.

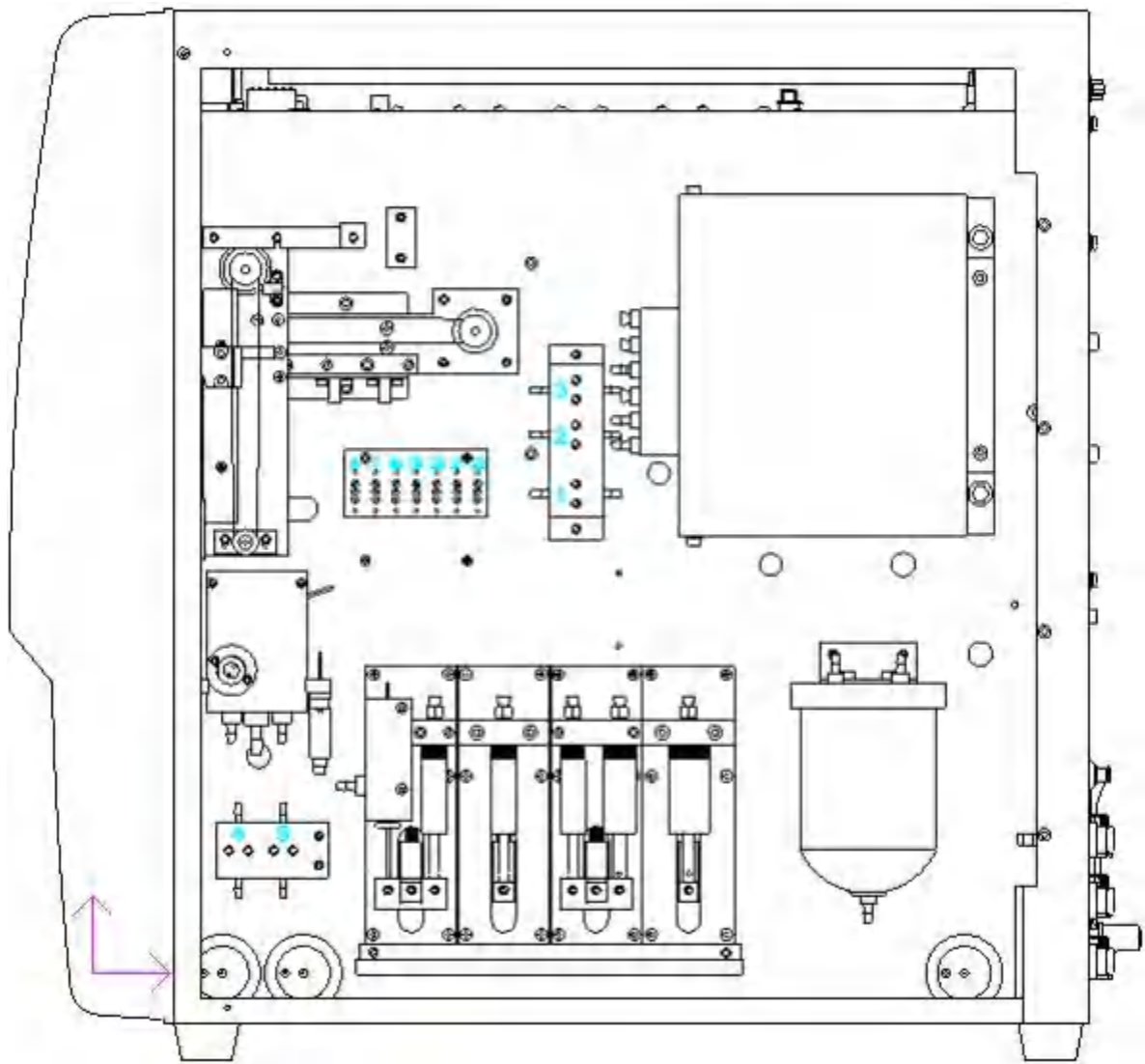

Figure 1-3 Front of the analyzer(front cover open)

- Do not put hands under the syringe or in the guide slot when the analyzer is running.
- Caution:Laser radiation when open and interlocks defeated avoid exposure to the beam.

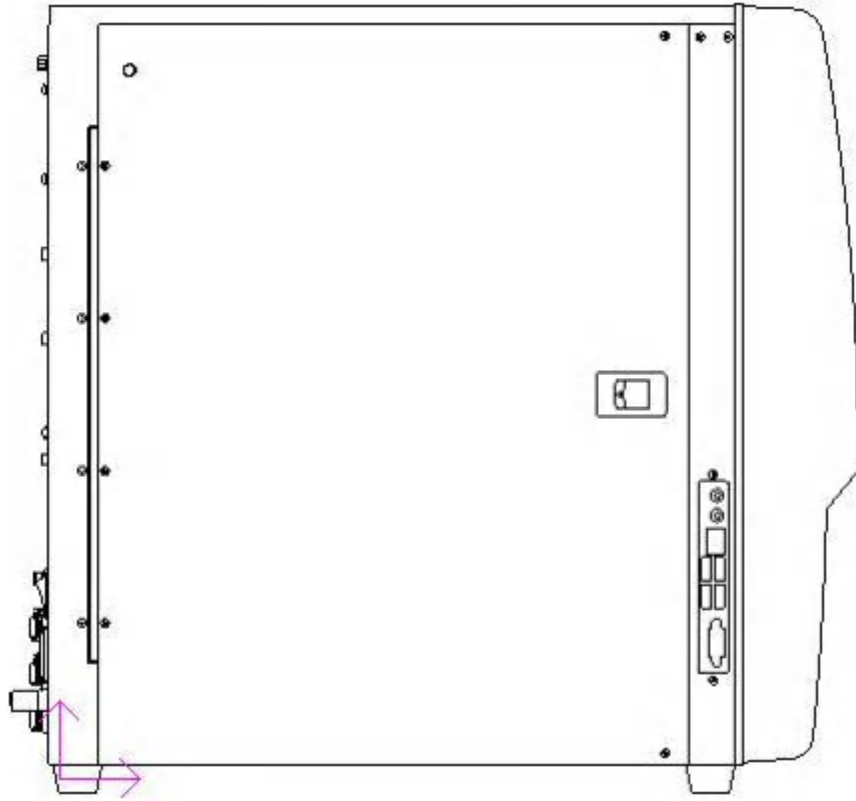

Figure 1-4 Left of the analyze

- USB port printer port and network port available in the lower right corner.

Chapter 2 System Outline

2.1 Introduction

This chapter introduce test parameters 、 main parts 、 operation interface 、 operation software 、 report setup and supplementary reagent of TEK8520 auto hematology analyzer.

2.2 Parameters

- This analyzer is using filtered clinical examination equipment. When make clinical judge according to analysis result, the doctor need consider clinical examination result or other test result in the meantime

The analyzer offer the below 27 parameters, 4 histogram, 1 scatter diagram, 2 test mode (CBC and CBC+DIFF)

中文名称 Chinese Name	缩写 Abbreviation	CBC	CBC + DIFF
白细胞数目	WBC	*	*
中性粒细胞百分比	Neu%	/	*
淋巴细胞百分比	Lym%	/	*
单核细胞百分比	Mon%	/	*
嗜酸性粒细胞百分比	Eos%	/	*
嗜碱性粒细胞百分比	Bas%	/	*
中性粒细胞数目	Neu#	/	*
淋巴细胞数目	Lym#	/	*
单核细胞数目	Mon#	/	*
嗜酸性粒细胞数目	Eos#	/	*
嗜碱性粒细胞数目	Bas#	/	*
红细胞数目	RBC	*	*
血红蛋白浓度	HGB	*	*
平均红细胞体积	MCV	*	*
平均红细胞血红蛋白含量	MCH	*	*
平均红细胞血红蛋白浓度	MCHC	*	*
红细胞分布宽度变异系数	RDW-CV	*	*
红细胞分布宽度标准差	RDW-SD	*	*
红细胞压积	HCT	*	*
血小板数目	PLT	*	*
平均血小板体积	MPV	*	*
血小板分布宽度	PDW	*	*
血小板压积	PCT	*	*
异常淋巴细胞数目 (研究参数)	ALY#	/	*

异常淋巴细胞百分比 (研究参数)	ALY%	/	*
巨大未成熟细胞数目 (研究参数)	LIC#	/	*
巨大未成熟细胞百分比 (研究参数)	LIC%	/	*
Cyto 直方图	Cyto Histogram	/	*
白细胞分布直方图	WBC Histogram	*	/
红细胞分布直方图	RBC Histogram	*	*
血小板分布直方图	PLT Histogram	*	*
分类散点图	Diff Scattergram	/	*

- —*|| means offering in this test mode , —/|| means not offering in this test mode

2.3 Product description



- Please check the all door/cover/board are in good condition,and be sure that they will not open or loose when the analysis runs.
- The analyzer is very weight,it may be hurt if only one people carry it.We suggest that two people carry the analyzer.When carrying,must follow relevant security rules and use some tools.



- It may be make the analyzer infect virus 、 cause system damage or data error if you install other software in the attached equipment or use for other usage(such as playing game 、 go internet).So pleasue be sure that the attached equipment only match up working for the analyzer.

2.3.1 Main unit

It is for finishing analysis and data process,it is the main part of this product

2.3.2 Power/status light

Power/status light is located in middle position of main unit's front right,it is using for indicating main unit's status,such as ready、 running、 bug 、 dormancy、 shutdown and so on.

2.3.3 Power switch

Power switch is located in the left of main unit,it is using for starting and shutdown main unit.



- Don't turn on/off power supply again and again in short time to avoid making main unit damage.

2.3.4 [Start] key

It is located in the right position of main unit's front right, it is used for starting count operation, adding sheath hematocrit or canceling dormancy.

2.3.5 Network port

There is 1 network port in the back of main unit, it is used for connecting other equipment.

2.4 Operation interface

After finishing start,the operator login follow interface.

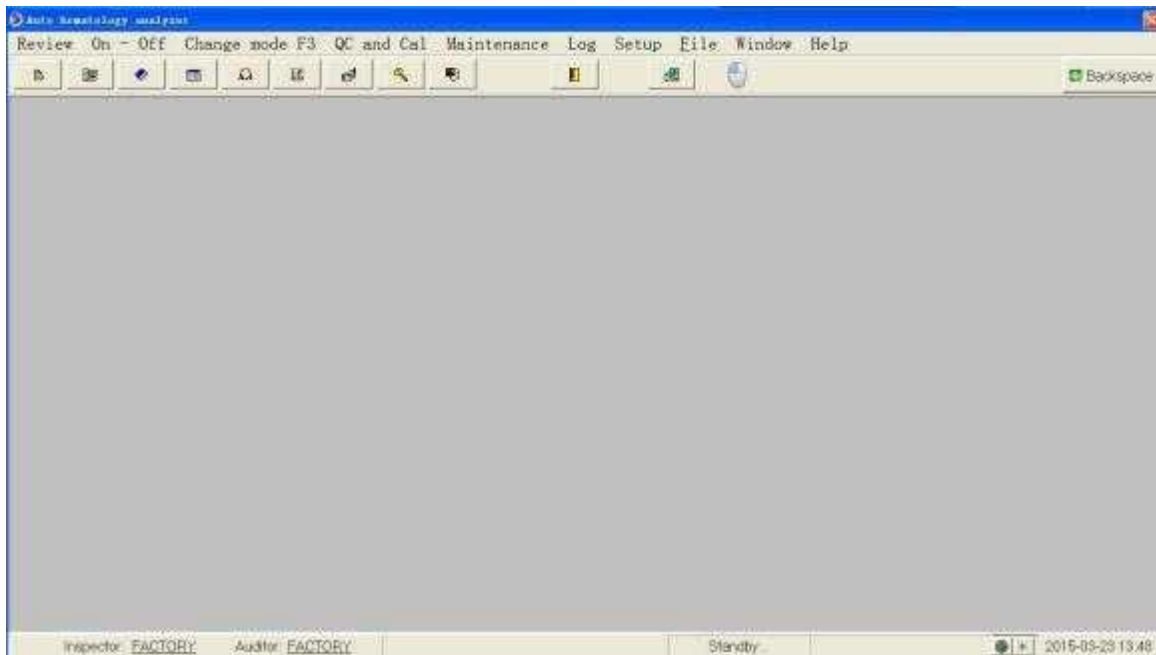
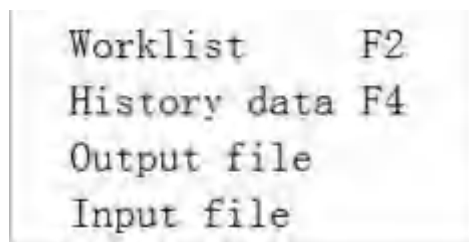

Chart 2-7operation interface

2.4.1 Main menu includes data query 、 start and shutdown 、 mode change F3 、 QC and Cal 、 Maintanance 、 log query 、 setup 、 doc F 、 Window and help.

1. Data query drop-down list includes:worksheet 、 histoical data 、 sample tray and guide docs.As below:



2. Start and shutdown drop-down list includes:start 、 shutdown 、 login and exit mode.As below:

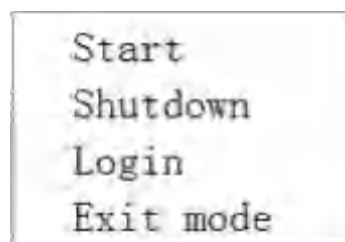

3. Mode change: This menu can open test menu, can choice different test mode, as below:



4. QC and Cal drop-down list includes: Whole blood QC 、 float mean value、 calibration, as below:

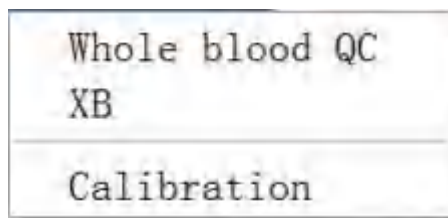

5. Maintenance drop-down list includes: Prime reagent and maintain 、 counting maintain and reagent manage, reagent manage includes: Prime sheath hematon 、 Prime enzyme detergent and Prime complex cell hemalyse. As below:

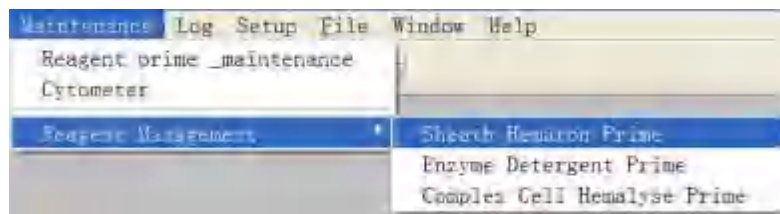

6. Log query drop-down list includes: alarm 、 reagent 、 maintenance and operation log. As below:

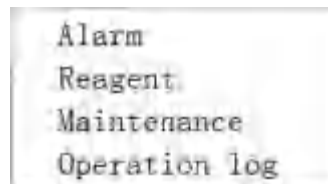

7. Setup drop-down list includes: item setup 、 language(CHINESE and ENGLISH) 、 sample message setup 、 system setup and user setup. As below:

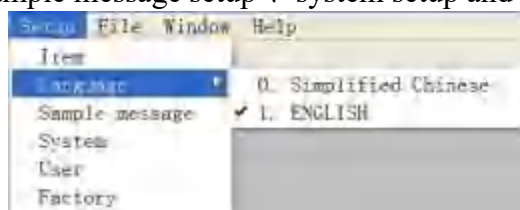

8.Doc F drop-down list includes:backup database B 、 recover database R 、 repair and compress database and delete database D.As below:

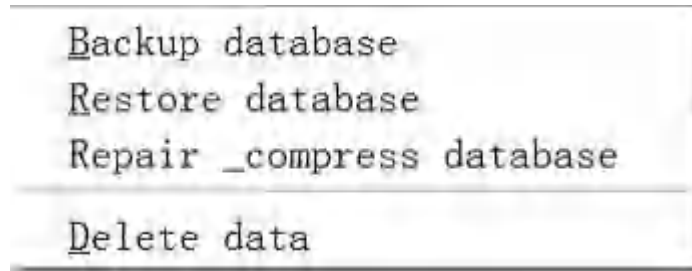

9. Window drop-down list includes:exit process and shut current window.As below:

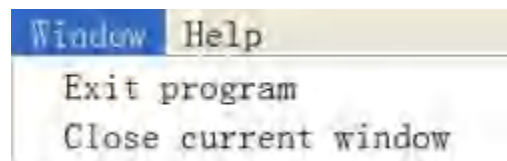

10. Help drop-down list includes:version and main page.As below:

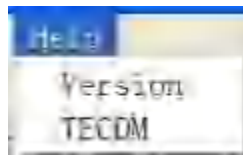

2.4.2 Shortcuts is toolbar,mainly includes:worksheet 、 mode change、 historical data、 itme setup、 Calibration、 whole blood QC、 login window、 change password、 shut keyboard、 shut current connector、 exit process and mouse key.As below:

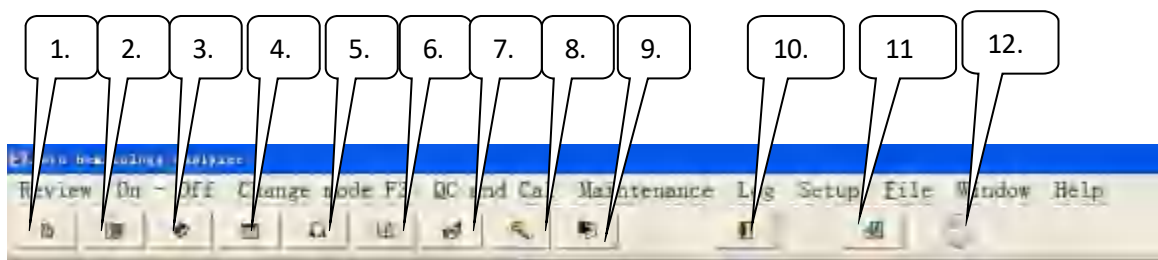

1. Worksheet:Can enter into work list after clicking
2. Mode change:Can choice different test mode after clicking
3. Historical data:Can search Continuously for a period of time all the test results after clicking,then make print to save and statistics.
4. Item setup:Can make test item setup,item print order and reference value setup after clicking.
5. Calibration:Can choice manual and auto calibration,check calibration history and current calibration factor.
6. Whole blood QC:Can choice multiple test item,QC test of different QC level

-
7. Login window: Can login window according to user's different requirement.
 8. Change password: Using for change password.
 9. Shut keyboard: Shut virtual keyboard of touch screen.
 10. Shut current interface: Shut current show interface.
 11. Exit process: Exit software.
 12. Mouse key: Using for switching the mouse left and right key.

2.4.3 Status area as below:



1. User unit (For example: DRAWELL Science Corporation)
2. Inspector
3. Auditor
4. Alarm indicate area: It will indicate in this area when analyzer has bug.
5. Mode: Current choice test mode.
6. Analyzer status
7. Main unit status
8. Date and time: show current date and time.

2.5 Software operation

Please be sure to be familiar with the follow basic operation or interface show meaning before using the software which match with the analyzer.

2.5.1 Touch screen location



1. Open software main program, Click the —Setup of —System setup.
2. Choice —Other, click —Touch screen location setup.
3. Choice advanced mode: Can choice 9, 16 and 25.
4. Click —advanced location.

2.5.2 Prime reagent

1. Check the all tube connect ok or not, include: sheath hematocrit, enzyme detergent, complex cell hemolysis and waste tube.
 2. Click main unit —Prime reagent and maintenance of —Maintenance.
 3. Click —Prime all.
 4. Click the —Execute prime reagent.
-

2.5.3 Background test

1. Click—Mode changell,choice —Blankl,click —Yesl
2. Click start key,make test.
3. Check result after test,if the result is not well,can test several times.

2.5.4 Sample test

1. Click the —Start and shutdownllin main menu,choice —Exit test model
2. Click the —Mode changellagain,choice the required test mode.For example:Whole blood-continue or prediluent-continue
- 3.Click—Yesl
4. Test sample directly

2.5.5 Historical data query and statistics

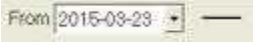
1. Click the —Historical data of —Data queryllin the menu or click the —Historical data ll in toolbar directly,enter into historical data connector.
2. Choice the required periods of time to check.For example 
3. Click —Searchll,then it will appear historical data.
4. Choice the required data in historical data,then click —Statisticsll,it will appear the window of statistics result.

2.5.6 Calibration

1. Manual calibration
 - 1) Continuous test same sample.
 - 2) Statistics,calculate mean value and target value deviation,then make manual calibration according to ratio
 - 3) Test different sample,make comparison between test result and target value.If the two value is almost,then ok.
2. Auto calibration
 - 1) Choice calibration mode,whole blood or prediluent.
 - 2) Click —Addll,input item of —Calibration setupll
 - 3) Input the calibration target value to the reference value corresponding test item.
 - 4) Click —Startll
 - 5) Change test mode,start testing sample.

2.5.7 QC

QC has two QC management procedure.

1. Whole blood QC, generally is based on the commercial quality control test results of the data and graphic quality management procedures,method is:
 - 1) Setup the required test item and QC level through —QC setupll
 - 2) Click —QC receptionll,choice test mode
 - 3) Sample test
 2. Float mean value,In generally,it will make mointorn according to MCV、MCH and MCHC.,Method is:
-

-
- 1) QC setup
 - 2) After finishing setup,it can save to click other location.
 - 3) Setup sample group and type,click—Save setup
 - 4) Change mode,test sample.
 - 5) Check X-B QC chart

2.5.8 Maintenance

Mainly includes : 1) Prime reagent and maintenance
2) Count maintenance
3) Reagent management

2.5.9 Log query

User can check all alarm 、 reagent change 、 maintenance and operation log message in the log query.Also can delete the log which don't need save.

2.5.10 Setup

Mainly includes item setup 、 language setup 、 sample message setup 、 system setup and user setup.

- 1) Item setup includes test item setup 、 print order setup and reference value setup.
- 2) Language setup include Chinese and english choice.
- 3) Sample message setup includes sample name、 remark、 application doctor、 patient type、 inspect department、 sample status、 diagnostic、 sex、 age unit and reference value setup.
- 4) System setup includes communication setup 、 print report setup 、 sample message indication setup and others.
- 5) User setup.

2.5.11 Windows

Mainly includes exit process and shut current window.

2.5.12 Explanation

- 1) Version

It main show current software and kinds of circuit board's version No.

- 2) Main page

Link the company website main page

2.6 Report setup and print

2.6.1 Report setup

Open main program,click —System setup\of —Setup\ .Enter into —Report setup\window,choice report print type.Such as:Full page without chart,half page with chart,half page without chart,full page with chart.

2.6.2 Print

In test interface,check the test result first,then click print,print after preview and check well.

2.7 Reagent 、 QC and Calibration

Analyzer 、 reagent 、 QC and calibration constitute a system,must be used as a whole to be sure system's performance.Operator must use DRAWELL specified reagent(See appendix B specification) .Or the analyzer may be damaged so that the performance index can not reach like user manual describe.Unspecified reagent can not ensure test result.The reagent appointed in the user manual is the reagent which analyzer uses supplementary reagent.

Please check the package before using each kinds of reagent.It will effect the reagent quality if the package damage,package ensure no damp and leak.If there is damp and leak,don't use the reagent.

- Please see the reagent's user manual about the reagent usage and storage.
 - Operator should make blank after change reagent,ensure the blank result in normal scope,get ready for sample analysis.
 - Ensure using the reagent in the reagent expiry date.
 - Reagents should stand for a period of time before use for its stability
-

2.7.1 Reagent

■ Sheath hematon

This product is a ph buffer action, appropriate ionic strength and conductivity of the electrolyte solution, used for blood sample dilution, forming a sheath flow, to analysis instrument for blood count, volume measurement and WBC count.

■ Complex cell hemalyse

This product is used for blood analysis before the destruction of red blood cells, stripping hemoglobin, dyeing processing, to maintain the required analysis of cellular form, so as to facilitate cell count or the determination of hemoglobin.

■ Enzyme detergent

This product contains the surfactant and high levels of proteolytic enzyme solution, used for equipment cleaning and flushing of piping system, can effectively clear the residual blood component and other particles affect blood count.

■ Concentrated detergent

This product is a kind of maintenance with a cleaning fluid, used for counting chamber cleaning, need to avoid light and save in 2 C to 8 C.

2.7.2 QC and Calibration

QC and Calibration is used for analyzer's quality contro and calibration.QC is a kind of industrial production of whole blood products,use for checking the analyzer's counting function.QC has low,middle,high levels.It can ensure analysis result good if run the three levels QC to check analyzer running condition.Calibration is also a kind of industrial production of whold blood products,use calibrate the analyzer.Please see the QC and Calibration's user manual to know the QC and Calibration usage and storage.

Chapter 3 System principle

3.1 Introduction

This analyzer using electrical impedance detecting red blood cells and platelets; Use of electrical impedance, laser scattering and specific chemical dyeing principle of white blood cell detection at the same time; Hemoglobin concentration are measured with colorimetric method; With semiconductor laser flow cytometry five classification statistics of attainment of white blood cell count. On this basis, the analyzer calculates the rest of the parameters of the results.

3.2 Mode

3.2.1 whole blood mode

After selection mode, tube sample blending; within the sample sample will suck the needle inserted into the open, suction sample button again can. After suction sample needle "10 μ l sample, add to the white cup, add the composite cell treatment agent, eventually form 1:210 dilution ratio, test the white blood cells and hemoglobin, red blood cells after secondary dilution, eventually formed 1:6260 dilution ratio, detecting red blood cells and platelets.

3.2.2 pre dilution mode

Select mode, press the "start" to trace the diluent allocation in blood vessels, and capillary vessels collected 20 μ l blood injection, blending after the test. Suction sample needle absorb about 100 μ l diluted sample, add to the white cup, eventually form when 5 dilution ratio, test the white blood cells and hemoglobin, red blood cells after secondary dilution, eventually formed 8693 dilution ratio, detecting red blood cells and platelets.

The an lang = EN - US > 1:210 dilution ratio, test the white blood cells and hemoglobin, red blood cells after secondary dilution, eventually formed 1:6260 dilution ratio, detecting red blood cells and platelets.

3.2.3 Blank mode

After the choice model, direct button test for testing background.

3.2.4 Whole blood- CBC

After selection mode, tube sample blending; Within the sample sample will suck the needle inserted into the open, suction sample button again can.

After being samples show results, white blood cells without classification test results, graphic display of red blood cells and platelets only graphics.

3.2.5 Whole blood- WBC

After selection mode, tube sample blending; Within the sample sample will suck the needle inserted into the open, suction sample button again can.

After being samples show the results, a classification of white blood cells and white blood cells and hemoglobin value test results, showing only

White blood cell classification scatter graphs, leukocyte graphics and CYTO graphics.

3.2.6 Whole blood- RBC

After selection mode, tube sample blending; Within the sample sample will suck the needle inserted into the open, suction sample button again can. After being samples show the results, only red blood cell value, platelets and red blood cell test results, the correlation show only Red blood cell patterns and platelets.

3.2.7 Whole blood- HB

After selection mode, tube sample blending; Within the sample sample will suck the needle inserted into the open, suction sample button again can.

After being samples show the results only hemoglobin test results don't show any graphics.

3.3 WBC measured

3.3.1 Laser flow cytome

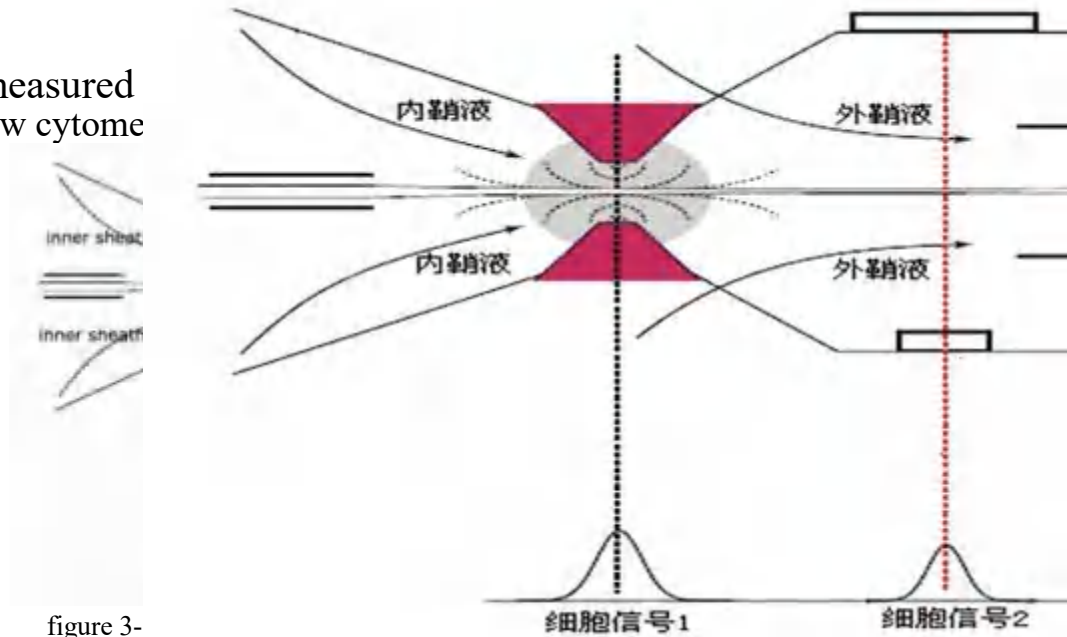

figure 3-

Through the analysis of electrical impedance and the laser scattering signal of white blood cell count and form a scatterplot to classify the WBC.

Sample test, instrument control suction, dilution, reaction temperature and reaction time these factors, but other factors also affected to the accuracy of the instrument test results, such as the blood, the blood of blending, such as supporting the use of reagents, the operators need to control, so the analysis of preparation is very important to the accuracy of the instrument analysis results.

500 to 1000 times the number of red blood cells, usually white blood cells, for the sake of the leukocyte count, must destroy the red blood cells. In red/platelets diluted, compound cell treatment agent added to the solution, destroy the red cell membrane, and the release of hemoglobin, and white blood cells to network stations at the same time. Then the solution by gem hole using resistance KangFa to count of white blood cells, as after a certain time Δt count after the completion of the solution into the laser test area, laser white blood cells, white blood cells after noted. immunohistochemical reaction of different category differently to the laser scattering signal, through the use of image analysis techniques and instruments software from the scatter plot of white blood cells are classified. For the laser test area as beyond the Δt scope will automatically be revised or alarm signal instrument.

As shown in figure 3-2, abscissa reflect cell internal complexity of information, the vertical reflection of cell volume.

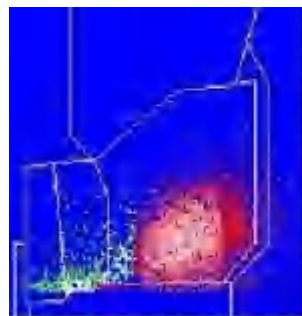

figure 3-2 DIFF Channel scatterplot

Available from DIFF channel scatterplot lymphocytes, monocytes, eosinophils and neutrophils and basophilic
Sex cells their respective percentage of the total number of white blood cells.

3.3.2 Impedance method principle

The analyzer by using the theory of Kurt to count white blood cells/basophils. The test sample after secondary dilution Enter the WBC testing unit. Detection unit has a small mouth, called detection holes. Holes on each side of a pair of positive and negative electric pole, connect the constant current power supply. Because the cell has the characteristics of poor conductor, dilute the sample cells under the action of constant negative pressure through the detection of holes, the dc resistance between electrodes will change, and on both ends of the electrode to form a fine The cell size is proportional to the pulse signal. When cells continuously through the small hole, generates a series of electric pulse on both ends of the electrode. The pulse number and the number of cells through the holes, the range of the pulse is proportional to the cell volume.

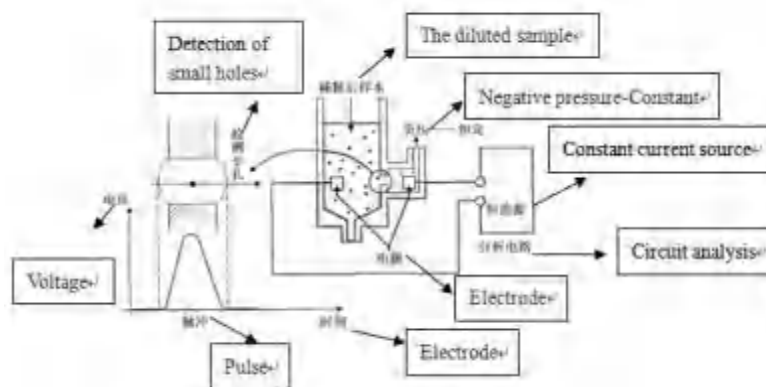

figure 3-3 The principle diagram of the count

By pulse voltage amplitude division of cells within the scope of each channel number determines the cell volume distribution. With horizontal cell volume, ordinate said the relative 2 d figure is reflected in the number of cells group distribution histogram.

3.3.3 WBC parameters

Analyzer to Diff channels through a scatter diagram and Lym area, area of Neu, Mon the analyses of regional and Eos lymphocyte percentage (Lym %), neutrophil percentage (Neu %), monocyte percentage (Mon %) and the percentage eosinophils (Eos) %. Combining resistance KangFa calculated, to obtain the number of white blood cells are lymphocytes number (Lym#), number of neutrophils (Neu#), number of mononuclear cells (Mon#), and the number of eosinophils (Eos#). Number of basophils (Bas#) can be directly obtained by resistance KangFa. Cell number of unit $10^9/L$.

Number of white blood cells

Analyzer through direct measurement of leucocyte number corresponding electrical impulses for number of white blood cell (WBC).

number of basophils

Analyzer through direct measurement of basophils corresponding number of electrical pulse number for basophils (Bas#)

Basophils

$$\text{Bas\%} = \frac{\text{Bas\#}}{\text{WBC}} \times 100\%$$

The lymphocyte percentage

$$\text{Lym\%} = \frac{\text{Particle number of the area of the Diff channel lagged in Lym}}{\text{In addition to the ghost area of all particles in a Diff channel count combined}} \times 100\%$$

Neutrophil percentage

$$\text{Neu\%} = \frac{\text{Particle number of the area of the Diff channel lagged in Neu}}{\text{In addition to the ghost area of all particles in a Diff channel count combined}} \times 100\%$$

Monocyte percentage

$$\text{Mon\%} = \frac{\text{Particle number of the area of the Diff channel is conditioned on Mon}}{\text{In addition to the ghost area of all particles in a Diff channel count combined}} \times 100\%$$

Eosinophil percentage

$$\text{Eos\%} = \frac{\text{Diff channel lagged in the number of particles of the area of the Eos}}{\text{In addition to the ghost area of all particles in a Diff channel count combined}} \times 100\%$$

Number of lymphocytes

$$\text{Lym\#} = \text{WBC} \times \text{Lym\%}$$

📁 Number of Neutrophils $\text{Neu\#} = \text{WBC} \times \text{Neu\%}$

📁 Number of mononuclear cells $\text{Mon\#} = \text{WBC} \times \text{Mon\%}$

$$\text{Eosinophils number} = \text{Eos\#} = \text{WBC} \times \text{Eos\%}$$

3.4 HGB concentration measurement

3.4.1 Colorimetric method

In the pool, and after being diluted sample hemolysis agent, dissolution of red blood cells, release of hemoglobin, the latter with composite cells after treatment combined with hemoglobin compound formation, the colorimetric one end of the pool to make LED light tube center wavelength of 540 nm light irradiation hemoglobin compound solution, on the other end through the photoelectric cell receives the transmitted light, and light intensity signal is converted into a voltage signal, after amplification with color in the pool before joining samples (color pool only diluent) measured background transmission intensity produced by the voltage comparison, get the hemoglobin concentration samples.

3.4.2 HGB concentration parameters

Hemoglobin concentration (HGB), calculated from the following formula unit is g/L.

$$\text{HGB} = \text{constant} \cdot \ln \frac{\text{Background through the light intensity}}{\text{Sample through the light intensity}}$$

3.5 RBC/PLT measurement

3.5.1 Impedance

The principle of the analyzer using impedance method in RBC detection unit of red blood cells/platelet counts. Detection unit has a small mouth, called detection holes. Holes on each side of a pair of positive and negative electrodes, constant current power supply connection. Due to the nature of cell has a poor conductor, dilute the sample cells under the action of constant negative pressure through the detection of holes, the dc resistance between electrodes will change, and on both ends of the electrode to form a with the cell size is proportional to the pulse signal. When cells continuously through the small hole, it is on both ends of the electrode to produce a series of electrical impulses. The pulse number and the number of cells through the holes, the range of the pulse is proportional to the cell volume.

Will be collected with normal red blood cells after electric pulse amplification/platelet volume range, in comparison with the corresponding channel voltage threshold to calculate the electrical pulse amplitude in red/platelets channel and the number of pulses of electricity. As a result, all the collected electrical voltage threshold are classified according to different channel, fell into the red/platelets within the channel number of electrical pulses is red/the number of platelets. By pulse voltage amplitude division of cells within the scope of each channel number determines the cell volume distribution. With horizontal cell volume, ordinate said the relative 2 d figure is reflected in the number of cells group distribution histogram.

3.5.2 RBC parameters

📁 Number of red blood cells

Analyzer through direct measurement of red blood cells, the corresponding number of electrical pulses to obtain the number of red blood cells (RBC), the unit is $10^{12}/L$

Average red blood cell volume

According to the red blood cell distribution histogram, calculate the average red blood cell volume (MCV), the unit is fL

Red blood cells deposited, average red blood cell hemoglobin content and average red blood cell hemoglobin concentration in the following formula to calculate the red blood cells deposited (HCT), unit for %; Average red blood cell hemoglobin content (MCH), the unit for pg. Average red blood cell hemoglobin concentration (MCHC), the unit is g/L

$$\text{HCT} = \frac{\text{RBC} \times \text{MCV}}{10}$$

$$\text{MCH} = \frac{\text{HGB}}{\text{RBC}}$$

$$\text{MCHC} = \frac{\text{HGB}}{\text{HCT}} \times 100$$

Among them, the RBC units is 10¹²/L, the MCV unit is fL, the HGB unit is g/L

Red blood cell distribution width coefficient of variation

Coefficient of variation of red blood cell distribution width (RDW - CV) by a red blood cell distribution histogram, the unit is %

Red blood cell distribution width of the standard deviation

Standard deviation of red blood cell distribution width (RDW - SD) by calculating the standard deviation of the red blood cell volume distribution, the unit is fL

3.5.3 PLT parameters

By directly measuring the platelet number analyzer corresponds to the number of electrical pulses to obtain the number of red blood cells (RBC), the unit is 10⁹/L

Mean platelet volume According to the platelet distribution histogram, calculate the mean platelet volume (MPV), the unit is fL

Platelet distribution width Platelet distribution width (PDW), are obtained by platelet distribution histogram for platelet volume distribution of the geometric standard deviation (10 GSD)。

Platelet deposited in the analyzer by the following formula (PCT), the unit is %

$$\text{PCT} = \frac{\text{PLT} \times \text{MPV}}{10000}$$

Among them, the PLT unit is 10⁹/L, MPV unit is fL

3.6 Rinse

Analyzer automatically in the process of each counting on the sample flows through each part to wash, to ensure liquid with sample residue left in the road.

Chapter 4 Installation

4.1 Introduction



- By DRAWELL company without being authorized or training of personnel out of the box or may cause personal injury or implement the installation process damage of the host. Please do not present in DRAWELL company authorized personnel cases out of the box or the installation host.
-

The analyzer has strict test before they go out. In order to avoid delivery hit, analyzer was carried out before shipping discreet packaging. When analyzer after the arrival of the goods, please carefully check the packaging of the analyzer, to see if there is physical injury, damage, if any, please immediately notify DRAWELL company's after-sales service agents or region.

4.2 Installation requirement

4.2.1 Space requirement

Ensure the needed space for repair and maintenance. Considering the normal flow of reagents without affection of instrument heat dissipation or squeezed liquid fluid conduit at the back of the host, the host installation must meet:

the reserved space between Host left and right side doors and the wall ≥ 100 cm

the reserved space between Host backboard and the wall ≥ 50 cm

Ensure there are enough space on the operating table and under the host, to place the sheath fluid stream, enzyme cleaning fluid and waste water containers.

4.2.2 Power supply



- The host must be used under conditions of good grounding
 - Make sure the input voltage meet the instrument requirements, before turning on the host
-



- Using power strip may incur additional electrical interference and lead to erroneous results. Please place the host near electrical socket to avoid using power strip.
- Please use the supplied power cord. Other power cords may damage the host or cause erroneous results.

	Voltage	Input Power	Frequency
Host	$\sim 99-242V$	1000 VA	50Hz \pm 1Hz

4.2.3 Environment conditions

- Working temperature range : 10 $^{\circ}C$ \sim 35 $^{\circ}C$
 - Working humidity range : not exceeding 90%
 - Working atmospheric pressure : 70 kPa \sim 106 kPa
 - Environment should be without dust, mechanical vibration, pollution, big noise source and power disturbances.
 - Assess the electromagnetic environment of the laboratory is recommended ,before operating the equipment.
 - Do not place the device near strong electromagnetic interference sources, to avoid affecting the normal operation of equipment.
 - Do not be close to brush type motors, flicker fluorescent lights and frequent switched electrical contact device.
 - Avoid direct sunlight and avoid placing it in front of heat source and air source.
 - Select a well-ventilated place.
 - Do not put the hosts on an incline.
-

4.2.4 Transporting and installing methods



- Transporting or installing the host by DRAWELL unauthorized personnel may cause personal injury or damage the host. Do not open the package or install the host, if DRAWELL authorized personnel are not present.



- In order to avoid damaging sampling component during the transport, we fasten them with a cable tie and clip when the instrument is shipped from our factory. Please remove cable ties and clips, before using the instrument.

The analyzer should be transported and installed by DRAWELL authorized & trained personnel. Do not transport or install the analyzer before contact DRAWELL service department or DRAWELL Agents.

4.3 System Connection

CAUTION

- Be sure to use the streaming sheath fluid drainage tube and liquid drainage tube length less than 1500 mm, all hemolysis agent drainage Tube and cleaning fluid drainage tube length are less than 850 mm.

As shown in the figure below, the electrical connections and reagents connection.

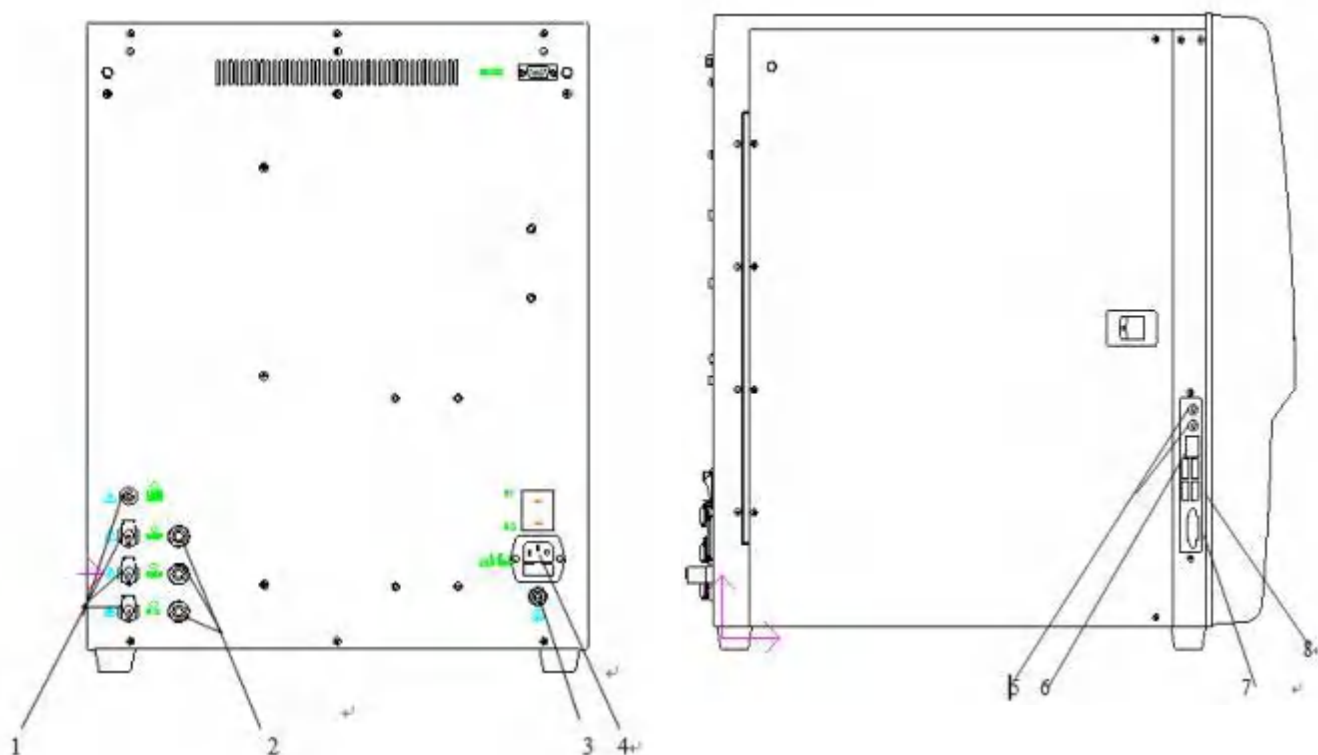

Figure 4- 1 electric hydraulic connection diagram

1. Top-down respectively by composite cells treatment agent, liquid flow sheath, enzyme liquid barrel cleaning fluid and connection.
2. Top-down respectively after try sheath liquid enzyme cleaning fluid, and connected to the liquid barrel sensor.
3. The grounding
4. The power socket
5. The headset
6. The network interface
7. The printer interface
8. The USB interface

Chapter 5 Setup

5.1 Introduction

This analyzer in the factory has been initialized setting, the first boot after the user interface is the system default. To meet the different needs of practical application, some parameters of the analyzer to be set.

In order to ensure product Settings and data security, analyzer, the operator will be divided into ordinary users and administrators two level permissions don't (administrator with ordinary users all permissions). Here will divide the two level this paper introduces the function of each set.

5.2 General management level

5.2.1 Setup

When the operator to general management level after logging in, click "Settings", on the main menu in the shortcut menu, select any item set, namely the pop-up Settings window.

Project Setup

Enter the Settings, click the project Settings "button, enter the Settings window.

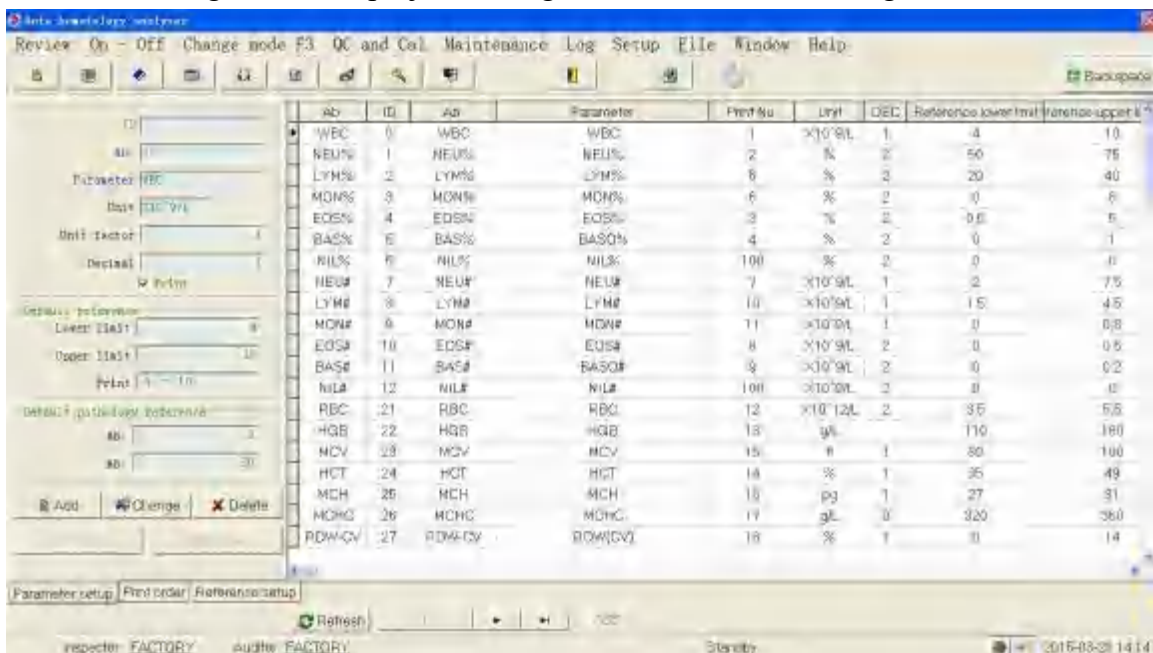

Project Settings, can be set print Settings and reference value

Language

Language can have two choices: simplified Chinese and ENGLISH. Move the mouse directly to the set of "language", you can choose the required language

Sample information set

Directly click on the "Settings" sample information set, can enter the following window:

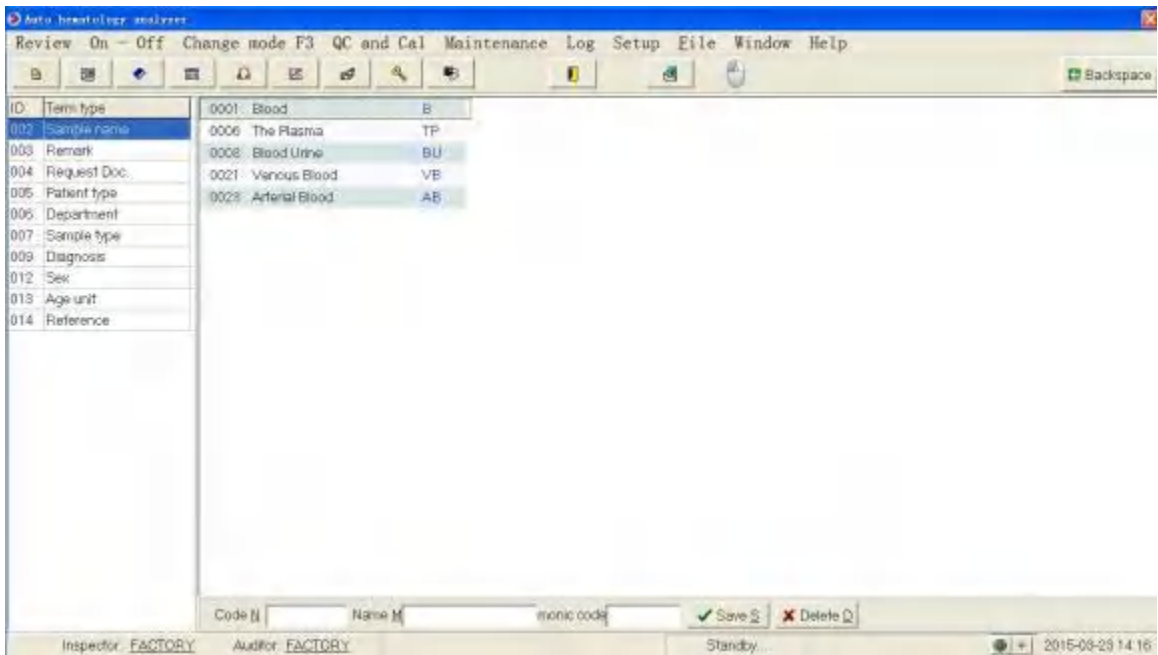

System Settings

Directly click on the "system Settings" set, can enter the following window:

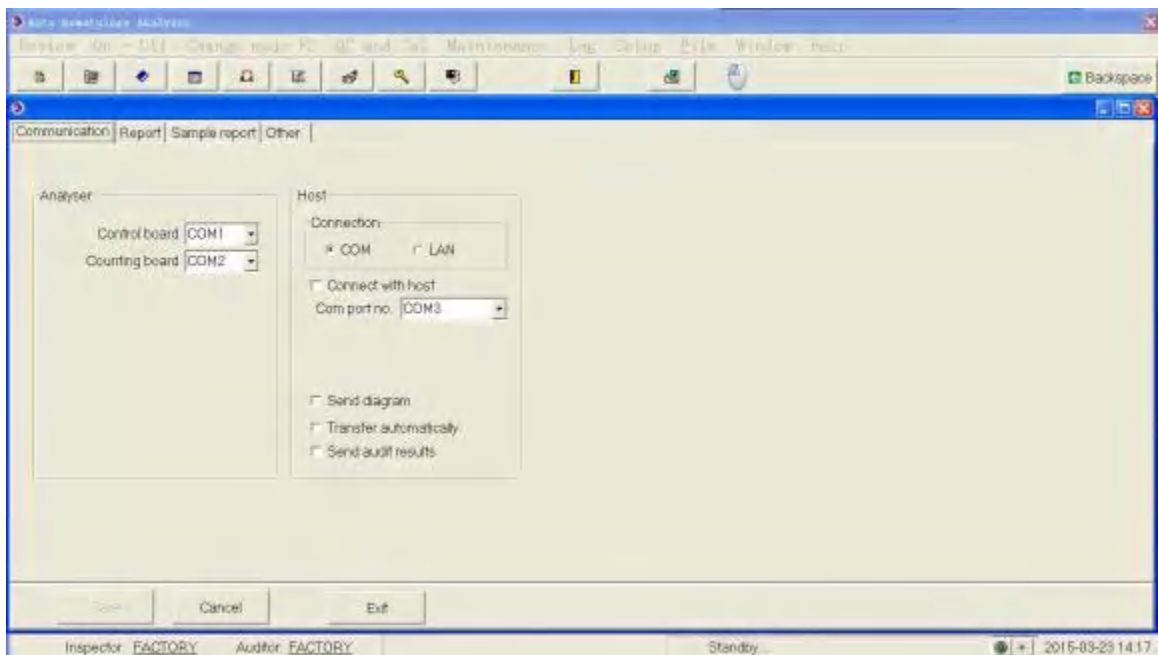

User Settings

Directly click on the "user Settings" set, can enter the following window:

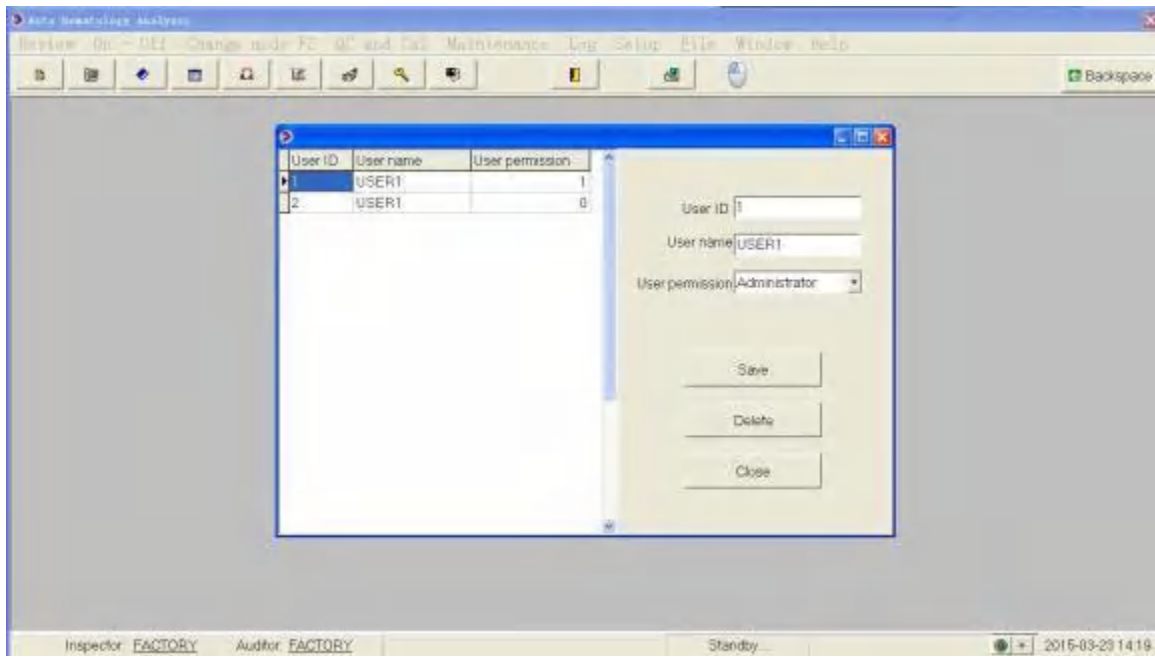

Effective code set reagent

Check the serial number of the reagent on the package for input Settings.

Chapter 6 Operating analyzer

6.1 Introduction

This chapter from the opening and closing of the daily operation process of the analyzer, focus on analyzing samples of different working mode operation process in detail.

Daily operation process is as follows:

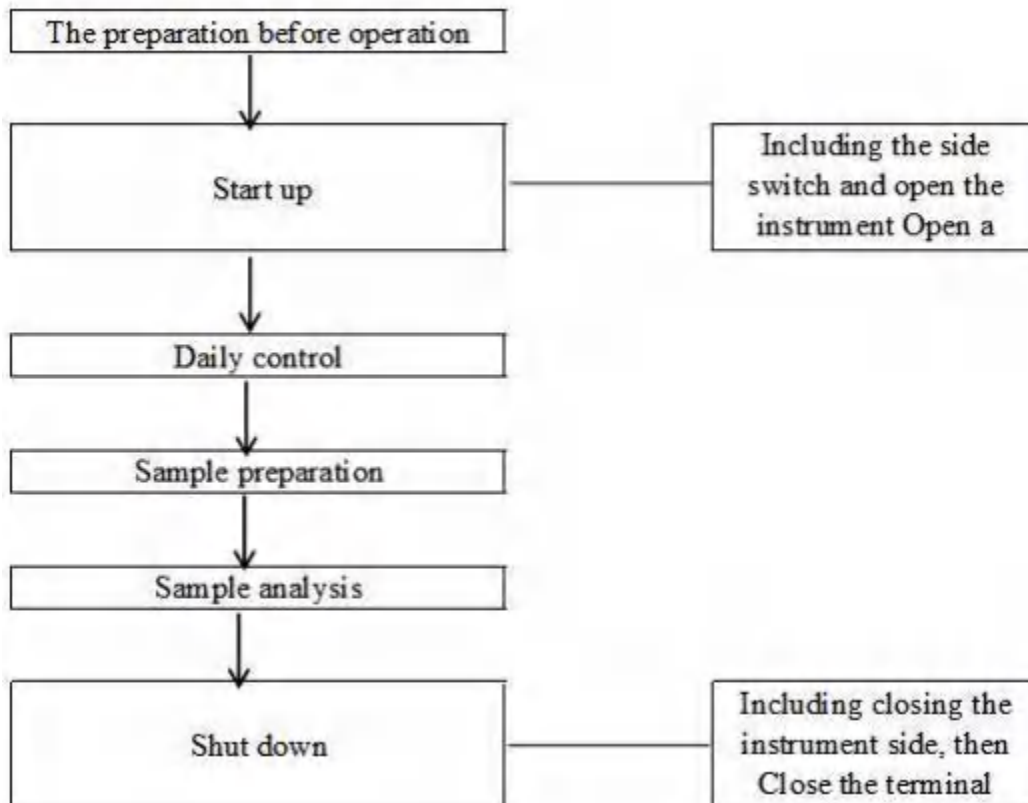

6.2 Initial Checks

Before opening the host power supply, the operator shall be in accordance with the requirements of the following check to make sure the system is ready

-
- 
- All items (sample, quality control, calibration, reagents, waste liquid, etc.), and the area of contact with these substances
Field has the potential biological infectious risk. Operator contact related items in the laboratory and the area, should according to laboratory safety operating rules, and wear personal protective equipment (such as laboratory protective clothing, gloves, etc.).

WARNING

- Operators have an obligation to abide by the area, state for reagents, waste liquid and waste samples, consumables, etc. And deal with the relevant provisions.
- Reagents may irritate eyes, skin and mucous membrane. Operator contact reagent related items in the laboratory, shall comply with the laboratory safety operating rules, and wear personal protective equipment (such as laboratory protective clothing, gloves, etc.).
- Reagent once in contact with skin, wash immediately with plenty of water, if necessary, please accept the doctor treatment; Reagent if contact with eyes, rinse immediately with plenty of water, and treated by doctors.
- Such as clothes, hair, hands must keep a certain distance with the moving parts, prevent the task by moving parts.

CAUTION

- The operator should use the company specified reagent, and in strict accordance with the instructions on the use of the reagents for storage and use.
- Before using the analyzer and reagent should check to ensure that the correct connection.
- Reagents should stand for a period of time before use for its stability

Check the liquid barrel

The operator must bring their own waste barrels, and ensure the daily before starting has been cleared.

Check the liquid line and power check reagents, waste liquid pipeline without bending, connection is reliable
Check the power plug host security inserted into the power outlet.

Check the printer (optional) check whether the printer paper is enough, if installed in place. Check whether the printer power supply is inserted into the power socket, the printer cable is connected to the instrument is ready

 Keyboard, mouse,

Check whether the keyboard and mouse cable connected to the external apparatus in place.

6.3 Startup and login

Start the host

1. The host on the left side of the "O/I" power switch in the "I", the power switch.
2. Confirm the indicator light on the host.

Start the external instruments and run the software

1. Open the external devices
2. Open the display
3. After completion of launch into the operating system, and then double-click "TEK8520 blood cell analyzer" icon, operation of installed software.



4. Software starts, pop-up is shown below the login dialog.

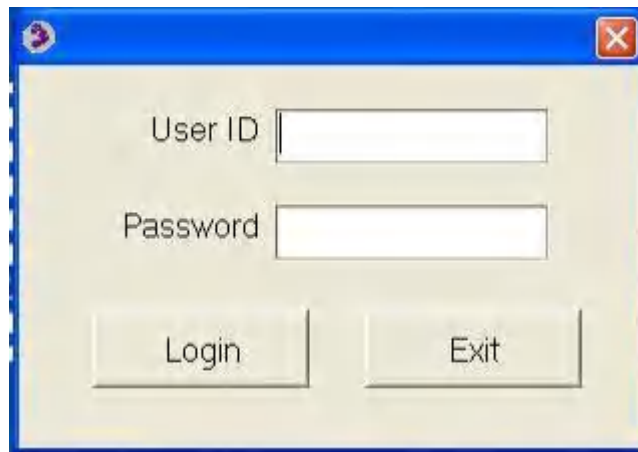

5. In the login dialog input the correct user name and password.
6. Click "ok" button, enter the main page.
7. Click "switch machine" in the "on", the instrument will be boot initialization and make an end of this test.
8. entire boot initialization process lasts about 3 ~ 5 minutes.
9. After the boot initialization, automatic check in interface, to see the boot background of test results.
10. Initialization is completed, if the bottom through the test, you can switch mode, testing samples.

6.4 Daily quality control

Before sample analysis, the daily quality control analysis was carried out on the analyzer, to ensure that the analyzer to get reliable analysis results. Specific operation method of the quality analysis of see Chapter 8 quality control.

6.5 Sample preparation



- All items (sample, quality control, calibration, reagents, waste liquid, etc.), and the area of contact with these substances
Field has the potential biological infectious risk. Operator contact related items in the laboratory and the area, should according to laboratory safety operating rules, and wear personal protective equipment (such as laboratory protective clothing, gloves, etc.).
-



- Do not direct contact with the patient's blood specimen.
-



- Don't repeat the use of disposable products.
-



- The operator should use clean K2EDTA anticoagulation vacuum vessels, silicide glass/plastic tube, and centrifugal pipe
Silicon boride glass capillary.
 - Please use conforms to the recommended size of the vacuum in blood vessels in the appendix.
 - Manufacturer designated specifications of the blood must be used in the vacuum vessel, the centrifugal tube, capillary and so on the disposable products.
 - In "automatic - whole blood" mode, click on the "add diluent" button, the system will automatically mode switch to "closed - whole blood", to perform and timing of diluent. Cancel adding diluent, then switch back to the original model.
-

6.5.1 Whole blood samples

1. Using K2EDTA (1.5 ~ 2.2 mg/mL) blood anticoagulation vacuum tubes to collect venous blood samples.
2. Rapid venous blood with anticoagulant fully blending of the tube.



- In enclosed sample and automatic sampling mode, to ensure that the whole blood sample size of not less than 1.0 mL



- Classification of white blood cells or platelets count sample shall be kept at room temperature, and analyzed in 8 hours after collection.
- If you don't need PLT, MCV, or white blood cell classification analysis, can be save in 24 C ~ 8 C refrigerator 2Hours. After cold storage of samples should be placed at room temperature for at least 30 minutes before analysis.
- Placed after a period of time of sample should be blending to anew for analysis.

6.5.2 Pre diluted sample



- Preparation of diluted sample, should choose specification 1.5 ml centrifuge tube.

1. The switch mode button click the main menu, select "pre dilution - continuous". At the same time, the pop-up dialog box as follows:

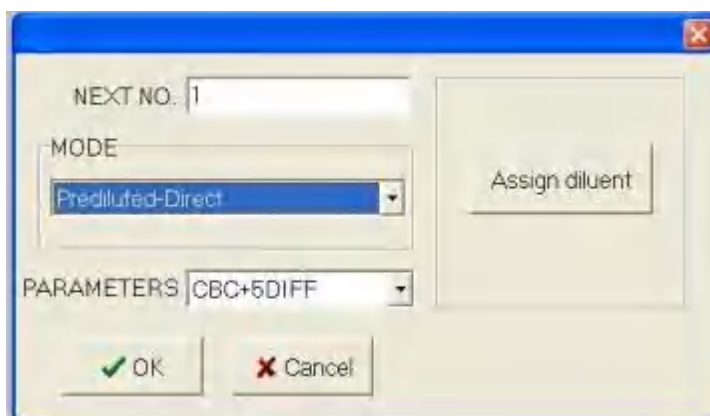

-
2. Click assign diluent, automatic into the distribution of diluent preparation.
 3. Take a clean centrifuge tube, under the suction sample injection. Press [to] on the host, start adding diluent of about 480 μ L for the amount of (a) L.
-

CAUTION

- If the current model for automatic sampling, the analyzer will automatically mode switch to the enclosed sample after add diluent.
 - Exit, and then automatically mode switches for automatic filling.
-

4. After adding diluent, long press the "start" button on the host. You can exit the diluent mode distribution.
 5. Collected 20 μ L of peripheral blood and quickly L injection containing diluent centrifuge tube, cover the lid after blending.
 6. If you need to prepare more diluent, can repeat step3.
-

CAUTION

- The operator can also use liquid move learn about 480 μ L diluent.
 - Preparation beforehand good diluent should avoid mixed with dust, otherwise it will produce analytical error.
 - Peripheral blood and diluent after full reaction, should be placed for 3 minutes, and then by blending can analyze again.
 - Ensure that within 10 minutes after the sample dilution were analyzed, and the analysis results are not reliable.
 - Placed after a period of time of sample should be blending to anew for analysis.
 - Each laboratory should according to their respective sample quantity, sampling method and the skill level to the dilution mode samples to evaluate the stability of the results
-

6.6 Sample analysis steps



- All items (sample, quality control, calibration, reagents, waste liquid, etc.), and the area of contact with these substances, Field has the potential biological infectious risk. Operator contact related items in the laboratory and the area, should according to laboratory safety operating rules, and wear personal protective equipment (such as laboratory protective clothing, gloves, etc).

CAUTION

- The sampling needle is pointed, the sampling needle may carry blood samples, quality control and calibration of potential biological infection
Sex, avoid contact with the sampling needle.

CAUTION

- Don't repeat the use of disposable products.
- Repeated puncture vacuum vessels might damage the rubber tube cap, the fragmentation may lead to inaccurate results. Suggest each vacuum vascular puncture times no more than three times.

CAUTION

- Before sample analysis need to be in "Settings" interface to select the appropriate parameters of the reference range, otherwise the analysis of the sample This may not be able to get the right after the alarm prompt.
 - If blood mode by its "diluted" switch to "whole blood", the analyzer will automatically execution mode when switching sequence, give the progress bar hints at the interface.
 - If the work order in accordance with the count, as under this number always closed sample pattern in the corresponding work order, the first is not blocked, record (or wrong) sample to be analysed, until the work order has been cleared or not unscreened record. If set in the "Settings" sample number entry way for increasing "automatic", so the follow-up analysis of sample number automatically add 1.
 - If you don't work order in accordance with the count, so will have to work order entry record without any influence.
 - If the Settings, select the use two-way LIS/HIS, then use the keyboard or bar code scanner into the sample After this number and save, read all relevant information from the LIS/HIS system, and then this information in accordance with the count. Immediately after the count, then the result data, graphics, sample/patient
-

Whole blood analysis

According to a single count

1. Select "whole blood - continuous" mode.
2. Under the counting the ready state (i.e. the status icon, instrument light green light), the whole blood samples in accordance with the mode shown below is shaking, with thorough blending samples.



3. Open cover, suction sample needle inserted into the sample under the liquid level
4. Click on the button and start testing.
5. After the analysis, status icon, instrument lights long recovery for the green light.
6. According to the process for the rest of the sample analysis.

CAUTION

- Sample no., measurement model from the backlog, the pattern of "continuous" whole blood - the first is not blocked, (or has to be analysed error) record the relevant information, and ash
 - Work order list mode for "whole blood - continuous" sample records is empty, "dialog box counting" interface "according to the work order execution count"
 - If the current interface not review interface, when the operator to switch to review interface, refresh the record information and results of the latest and graphics.
-

CAUTION

- Execute a dilution - sample analysis of continuous mode, want to choose the centrifugal pipe specification is 1.5 ml.

According to a single count

1. Prepare well diluted sample diluents.
2. Select "whole blood - continuous" mode.
3. Open cover, suction sample needle inserted into the sample under the liquid level.
4. Click on the button and start testing.
5. After the analysis, status icon, instrument lights long recovery for the green light.
6. According to the process for the rest of the sample analysis.

6.7 Entry work sheet information

In automatic injection mode, the operator can input sample to be analysed before sample analysis work order information.

CAUTION

- Abnormal close work order has not yet been saved in the sample information loss, as a result of chance.
- If the operator want to analyze again after inputting the complete work order information, please refer to chapter 7 review results.

Click the shortcut button "work order" button or click "menu" button, select menu item into the "work order" interface.

Operators to click "add" button, to add a new record in the bottom of work order list, and highlight in the list.

Display this blank records. Information recorded in various fields have shown a default value and start

CAUTION

- The analysis of the new record status to "analysis".
 - Can use [Tab] key, in the sample information/patient information switching among various options. see In the fifth chapter set "general setup" section after set, also can use [Enter] key to switch.
-

-
- Use [Tab] or [Enter] key to switch options, you can skip some don't need to input options, Settings refer to chapter 5 set in "general Settings" section.
-

The input sample number

In the "sample number" box input sample number.

CAUTION

- Sample number allowed to enter letters, Numbers, and the keyboard support all of the characters (including special characters).
 - Sample number allows the length of the input range of [1], and can't be empty.
 - The end of the sample number must be numeric characters, but the sample number can't for the number "0".
-

Select mode

Respectively in the drop-down list to choose sample way to "automatic", measuring mode "CBC" or "CBC" + DIFF

CAUTION

- If you select automatic sampling, sample mode can only be "whole blood", at this point, the blood sample model combo box ash show,Do not allow the operator to select its "diluted" mode.
 - "CBC" measurement mode only count, no classification of white blood cells, counting result contains 13 parameters and the histogram of the WBC, RBC, PLT;"CBC" + DIFF measuring model count and five classification of white blood cells count, classification result in addition to all 23 parameters a scatter diagram and the WBC/BASO histogram, RBC, PLT, include four research parameters.
-

Select the reference group

In the "reference group" drop-down list, select the sample set of reference. Analyzer based on the reference range for the selected reference group to judge the result of the count and the results of beyond the normal range for alarm.

CAUTION

- If the operator input the patient's gender, age, then the system according to the corresponding relations between automatic matching reference group.
 - If that matches the reference group and the operator had selected reference 5 reference group (custom) differ, the reference group, the use of the automatic matching.
-

Input sampling time

Choose the sampling date in the date controls, in the edit box time input sampling time

- Input inspection time Choose the inspection date in the date control in time in the edit box input sample inspection time.
-

CAUTION

- Inspection date/time is not before the sampling date/time.
 - Sampling and inspection date/time is not in the current system date/time.
-

CAUTION

- Pipe rack, the input range [1100], in vitro, the input range (1, 10]. Pipe rack and tube is not allowed is empty.
-

Input in the hospital No.

The "hospital" box enter the patient's in hospital.

CAUTION

- If use one-way LIS/HIS, if existing and enter the case number of corresponding patient information, medical records are input
After the number, press [Enter], automatic display on the interface and the matching patient information (name, gender, age, date of birth, the type of patient, don't, desk, bed number), allows the operator to modify again. Among them, the number of age values will be automatically calculated based on the current system date.
 - If use two-way LIS/HIS, if the case number automatically match information and download the information on the LIS/HIS conflicts, the default for the LIS/HIS download information
-

Enter the patient's name

In the "name" box enter the patient's name

Enter the patient gender In the input field "gender" or the "gender" drop-down list, select the sex of the patients.

Input analyzer in patients of different ages, patient age provides four age input methods: according to "age" input, according to "on" input, according to the "day" and "the hours" input. Respectively suitable for: people older than one year, the full moon, but the year old people, more than one day but not full month of birth and birth less than 24 hours. Operator can choose according to ages of patients with the age of input methods.

In the "age" drop-down list, select the age of the input mode for "age", "month", "day" or "hour", and before the age of unit in the input box input patient age.

CAUTION

- Input date of birth, age field will be based on "the current system date" and "date of birth" since the difference between the values Dynamic calculation, and the age numerical edit box and unit in the combo box shows the age of the new calculation value with the unit. At this point, the edit boxash show age, empty, after the "date of birth" age of edit box to restart.
-

Input samples type

In the name of "specimen" box input or in the name of "specimen" drop-down list, select the patient type.

State of specimens in the input field "specimen" or the "specimen" drop-down list choose patient specimens

Enter the department In the input field "inspection department" or in "inspection department" drop-down list, select performing sample analysis department name (records) of the drop-down list.

Enter the bed, In the input field "bed" patient's bed.

Enter the applicant's name In the input field "to apply for the doctor" or the "doctor" application drop-down list to apply for the doctor's name (records) of the drop-down list.

Input content clinical diagnosis In the "diagnosis" box enter some suspected diagnostic information.

Input note content In the "remarks" box input some information need to claim.

-  After completing the work order information input, click "save" button or press the shortcut Alt + [S], save the current all information.

CAUTION

- The current record "sample number + model" or "+ tube, pipe rack on" can't "analysis" and not a shield,"Analysis" or "error" state of the record duplication.
- If the Settings, select the use two-way LIS/HIS, is the operator after click "save" button, the terminal software from the LIS/HIS first match the sample number of information, and displayed in the corresponding field.

6.8 The results of the analysis process

The results of the analysis of preservation

Analyzer can automatically save the results of the analysis. As the number of sample results to storage period, new sample analysis results will be automatically covered the old, have backup samples analysis results. Number of sample results to store up to 40000.

Parameters of the alarm

~~In the parameter results on the left side of the show "-" or "+", the analysis results~~

of said more than preset parameters reference range, but also within the scope of the display.

In the parameter results show the left side of the "?"The analysis results of said, get suspicious.

☞ Analysis results are shown as "* * *," said invalid or exceed the range measurement result.

CAUTION

➤ Analyzer not this parameter alarm and classification of monitoring results of bottom or form abnormal alarm.

Classification or form abnormal alarm

Analyzer according to the scatter plot and the histogram of the WBC, RBC, PLT exception or suspicious alarm, the tooltip righteousness be shown in the following table.

Information types		Flag prompts
WBC	abnormal	Abnormal white blood cells scatter plot
		Abnormal WBC histogram
		Abnormal white blood cells
		White blood cells increase
		White blood cells reduce
		Increased neutrophils
		neutropenia
		Lymphocytes increase
		lymphopenia
		Monocytes increase
		eosinophils
		basophils
	suspicious	Nuclear left?
		Immature cells?
Abnormal/heterotypic lymphocytes?		
Erythrocyte hemolysis resistance?		
RBC/HGB	abnormal	Red blood cells to increase
		Abnormal red blood cell distribution
		Red blood cell size
		Large cell sex red blood cells
		Small cell sex red blood cells

		bimodality
		anemia
		Low pigment
	suspicious	The abnormal hemoglobin/interference?
PLT	abnormal	Abnormal platelet distribution
		Increased platelet
		thrombocytopenia
	suspicious	Platelet aggregation?

Analyzer according to the scatter plot and the histogram of the WBC, RBC, PLT exception or suspicious alarm, the results of each parameter The influence of the shown in the following table.

category	alarm	Whole blood		Pre dilution	
		CBC	CBC+5DIFF	CBC	CBC+5DIFF
WBC	Abnormal white blood cells	×	√	×	×
	Erythrocyte hemolysis resistance?	×	√	×	×
	Abnormal white blood cells scatter plot	×	√	√	√
	Abnormal WBC histogram	×	√	√	√
	Nuclear left?	×	√	×	×
	Immature cells?	×	√	×	×
	Abnormal/ heterotypic lymphocytes?	×	√	×	×
	White blood cells increase	√	√	√	√
	White blood cells reduce	√	√	√	√
	Increased neutrophils	×	√	×	×
	neutropenia	×	√	×	×
	Lymphocytes increase	×	√	×	×
	lymphopenia	×	√	×	×
	Monocytes increase	×	√	×	×
	eosinophils	×	√	×	×

	basophils	×	√	×	×
RBC/HGB	bimodality	√	√	×	×
	The abnormal hemoglobin/interferen	√	√	×	×
	Red blood cell size	√	√	×	×
	Small cell sex red blood cells	√	√	√	√
	Large cell sex red blood cells	√	√	√	√
	Red blood cells to increase	√	√	√	√
	anemia	√	√	√	√
	Low pigment	√	√	√	√
	Abnormal red blood cell distribution	√	√	×	×
PLT	Platelet aggregation?	√	√	×	×
	Increased platelet	√	√	√	√
	thrombocytopenia	√	√	√	√
	Abnormal platelet distribution	√	√	×	×

CAUTION

➤ When the platelet count below $100 \times 10^9 / L$, suggest using microscope count.

6.9 Shut down



- All items (sample, quality control, calibration, reagents, waste liquid, etc.), and the area of contact with these substances Field has the potential biological infectious risk. Operator contact related items in the laboratory and the area, should according to laboratory safety operating rules, and wear personal protective equipment (such as laboratory protective clothing, gloves, etc.).
-
-

CAUTION

- Sampling needle sharp, and may be stained with biological pollution hazard substance. Please be careful when the host operation, cut Do not contact with the sampling needle
-
-

CAUTION

- In order to guarantee the stability of the analyzer and the accuracy of the results of the analysis, in the analyzer working at 24 hours straight, please Perform shutdown operation, in accordance with the requirements.
 - The operator must follow the steps below to perform normal shutdown procedure to turn it off.
-
-



Shutdown contains close host and exit the software two parts. There are, respectively, in "exit software system" and "close the host instrument" introduces the operation steps.

Exit the terminal software

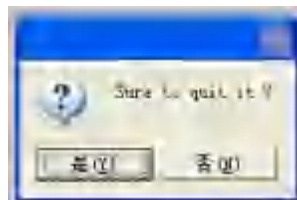
1. Click on the main menu "switch machine" in the "off", the pop-up dialog box as follows.



Click "ok" button, automatic shutdown procedure

2. Just click the toolbar "exit"  Or click close button  Exit the program.

Shut down the host

1. First off the scree
 2. Power outages
-

Chapter 7 Review results

7.1 Introduction

After each perform the sample analysis, automatic analyzer are the sample information, the result data, Flag prompts, histogram and scatter diagram stored in the review database. Analyzer sample library can store up to 100,000 sample records.

Operator can in graphics review, review the list interface, graphics, lists, way, to review the samples stored in the database information, the result data, Flag prompts, histogram and scatter plot.

7.2 Image review

Click " Worklist " in " Review " of main menu or click " Worklist " directly in toolbar.

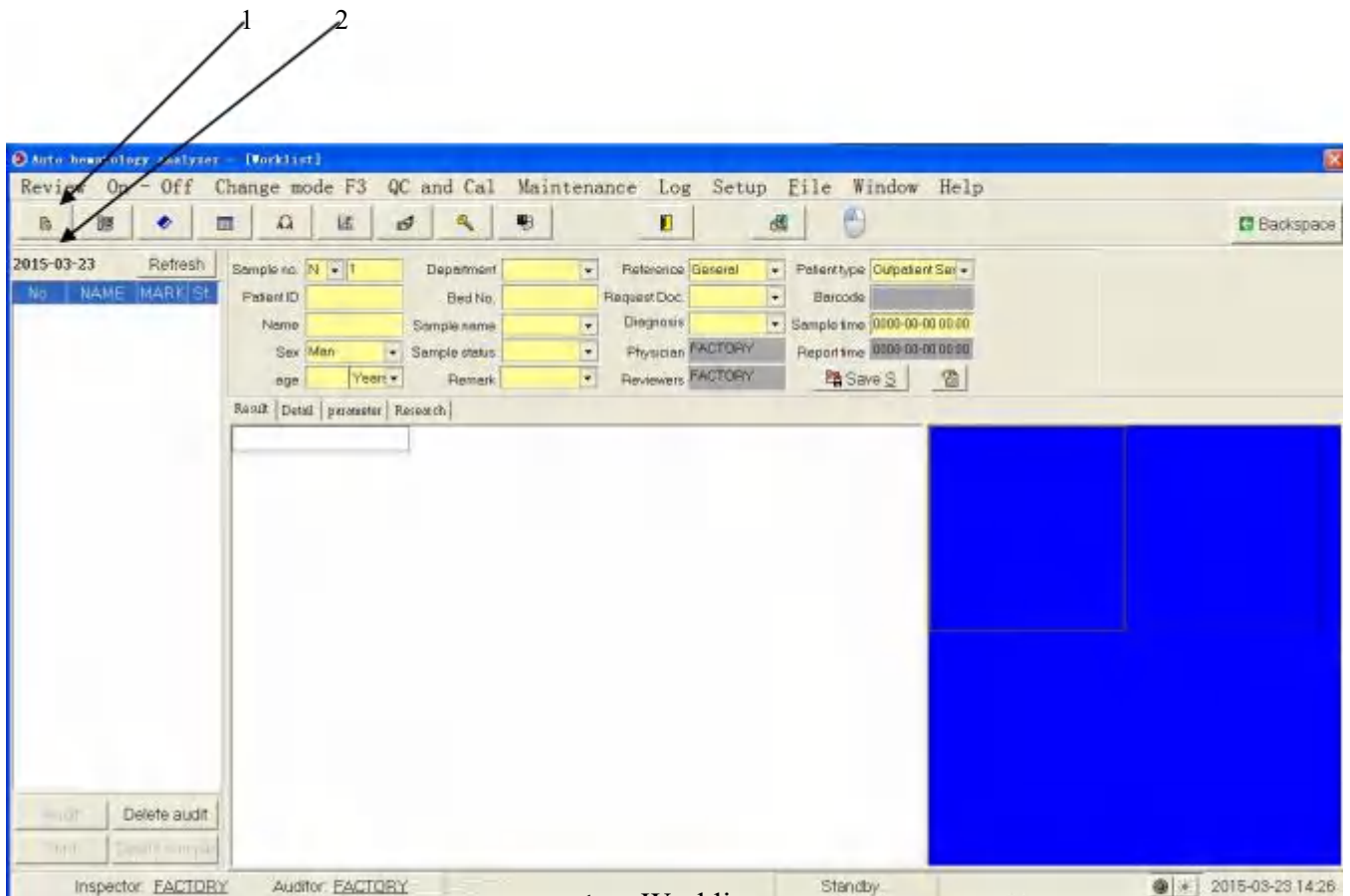

1. Worklist
2. Date

Choose date of test results you want like " 2014-02- 14 " and click " Yes " as following picture.



Upper of the interface shows the sample/patient information and middle shows relative test results and right side shows the histogram and scattergram.

7.2.1 Sample/Patient Information

Operator can use record swift bar on bottom right to review each sample record. Upper interface shows the sample/patient information. In this information, operator can edit directly except " Physician " and " Reviewers " . To know more information about how to edit, pls refer to 6.7 Edit Worklist Information



- If operator want to edit sample ID, pls set in " setup " . To know more information, pls refer to Chapter 5.
- In sample information interface, operator can edit all information except " Mode " " sample position " " check time "

7.3 List review

Click " Review " and " History Data " or click " History Data " directly in tool bar and will show following picture.

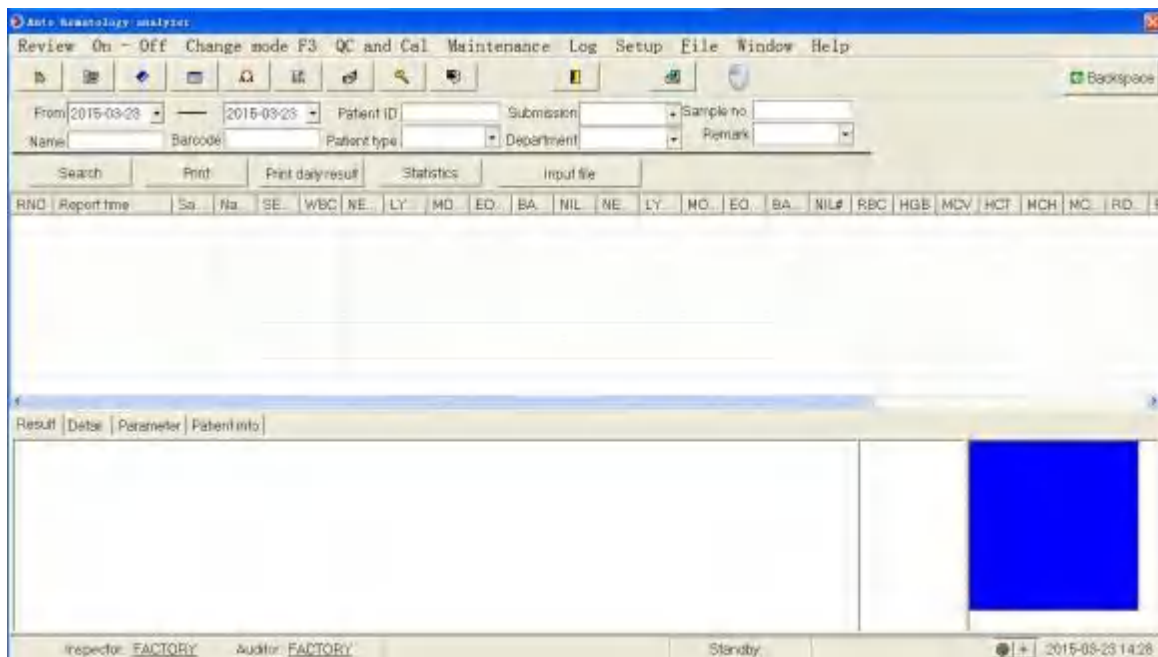

7.4 Bulk print archive list

1. Choose daily result record going to be print like following picture



Click " Print Daily Result " to show print preview as following picture.And then lick print



7.5 Output File

Click " Review " and " Ourput File " and will show following picture

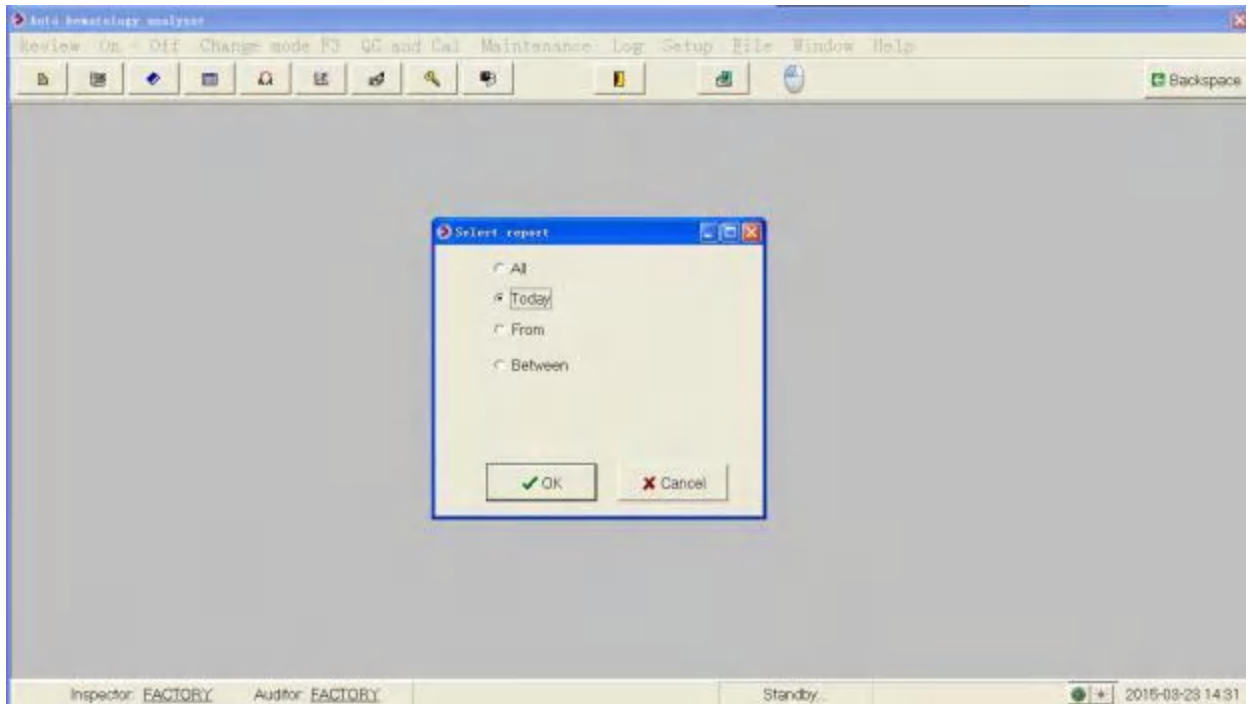

Can selected by the required disk time

7.6 Input File

Click " Review " and " Input File " and will show following picture.

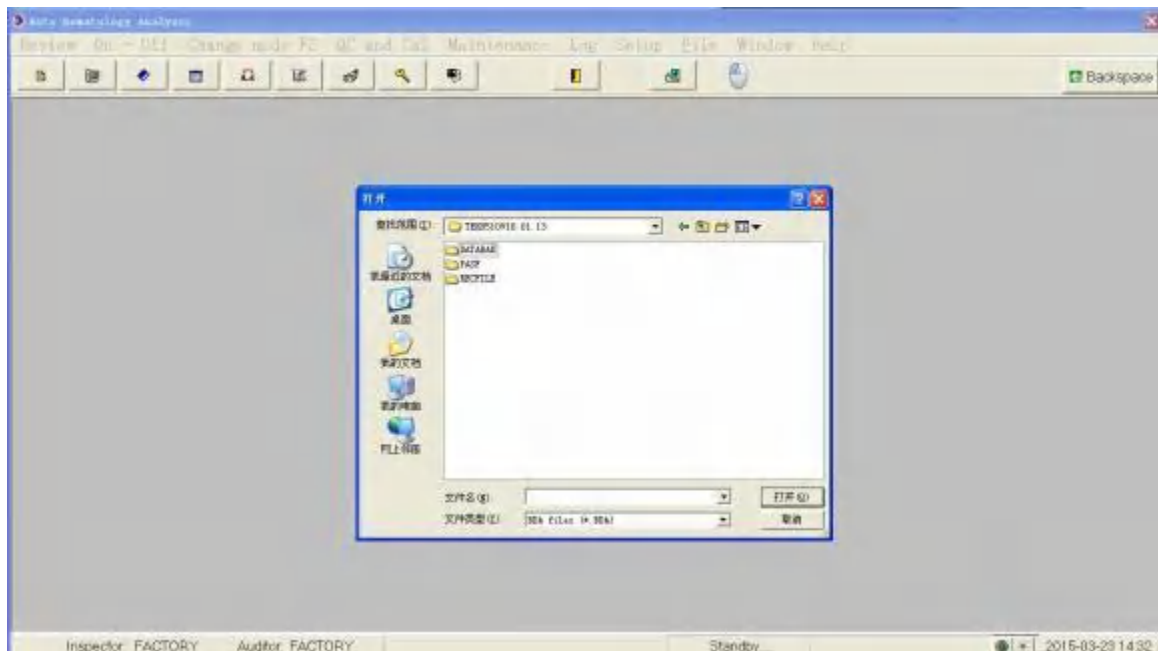

Choose the file you want,click " Open ". Then enter History Data interface automatically and show the input file information.

TECOM SCIENCE CORP. 数据查询 开关机 模式切换 FS 质控与校准 保养及维护 日志查询 设置 窗口 帮助

从 2014-02-14 2014-02-14 住院号 送检医生 标本编号
姓名 条形码 病人类别 送检科室 备注

检索 打印存档单 统计 选择外部数据

NO.	报告时间	标	姓名	WBC	NE	LY	MO	EO	BA	HIL	NE	LY	MO	EO	BA	PLT#	RBC	HGB	
247	2014-02-14 15	N135		0.1	0	0	0	0	0	0	0	0	0	0	0	0	0.05		
246	2014-02-14 15	N134		5.8	59	35	15	0.05	0.32	2	1.7	0.5	0.8	0.07	0.01	0	4.95	145	145
245	2014-02-14 15	N133		2.0	59	36	33	0.45	0.27	0	1.4	0.3	0.7	0.01	0.01	0	4.18	122	122
244	2014-02-14 15	N132		2.7	60	25	13	0.75	0.28	2	1.5	0.7	0.4	0.02	0.01	0	4.22	122	122
243	2014-02-14 15	N131		2.1	61	24	13	1.15	0.21	1	1.3	1.1	0.4	0.02	0.01	0	4.31	122	122
242	2014-02-14 15	N130		3.9	52	30	14	0.7	0.63	2	1.3	1.3	0.4	0.02	0	0	4.18	122	122
241	2014-02-14 15	N129		2.1	61	23.3	11	0.61	0.2	0	1.3	0.9	0.4	0.02	0.01	0	4.11	122	122
240	2014-02-14 15	N129		0.1	0	0	0	0	0	0	0	0	0	0	0	0	0.96		
239	2014-02-14 15	N127		5.9	64	16	13	0.63	0.22	0	1.4	0.9	1	0.03	0.01	0	3.75	122	122
238	2014-02-14 15	N126		5.2	56	21	21	0.28	0.19	0	2.9	1.1	1.1	0.01	0.01	0	3.5	122	122

1 2 3 4 5 6 7 8 9 0 - -

Tab q w e r t y u i o p | | |

Lock a s d f g h j k l ; ' Enter

Shift z x c v b n m . / Shift

Alt Alt Ctrl

TECOM SCIENCE CORP. 检验者:TECOM 审核者:TECOM 全血-连续S/D/S 2014-02-22 09:28

Chapter 8 Quality Control

8.1 Introduction

Long working time of hematology analyzer may cause some deviation which will cause wrong or unreliable result. QC process is an effective method to test the deviation. Operator only familiar with theory of QC and actual operation method can eliminate deviation effectively towards test result. To ensure the accuracy of result, it is suggested to do quality control one time for high, normal and low level each day. When we need to use new QC in new Lot number, do two QC at the same time for 5 days and each day two times. QC test result should be in the reference range of the QC user manual. This instrument provides 4 kinds of QC method, L-J Control, X average Control, X-R Control and X-B Control.

CAUTION

- Operator should use the QC and reagent as we suggest and store and use QC and reagent according to user manual.

8.2 L-J QC

8.2.1 Edit QC



- All things (Sample, control, calibrator, reagent and waste) and area that touched by those things have potential risk of biological infection. Operator who have access to those things and area should comply with laboratory safety operation regulations and wear protective cloth (protective clothing, gloves and so on)

CAUTION

- Only Admin operator can have permission to edit Control information.
- To those QC file which have QC result, if change the parameter reference range or deviation, then the change file will lighten by yellow color and save in log.

Before new Control used, it is necessary to set a control file for each Lot of

control. There are three methods to edit control information.

To read from storage information provided from control manufacturer

Input by hand

To read from default information

Enter into QC chart interface

1. Enter the quality control diagram interface by any of the following ways:

📁 Click "QC and Calibrate" in main menu

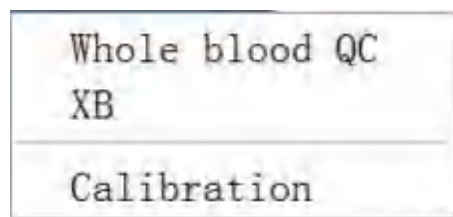

QC including "whole blood QC and X-B

8.2.2 QC Analysis

Operator can choose two methods to process QC analysis according to their habit.

Using QC and test in QC test interface.

Treat QC as sample and process QC analysis in sample test interface.

Using QC and test in QC test interface

After QC parameter setting, choose one model to test QC

Whole blood-continuous

Predilute-continuous

QC analysis (Whole blood-continue)



- All things (Sample, control, calibrator, reagent and waste) and area that touched by those things have potential risk of biological infection. Operator who have access to those things and area should comply with laboratory safety operation regulations and wear protective cloth (protective clothing, gloves and so on).



- Sample needle is sharp and may have something of biological infection. Operator must be very careful when handle the machine and do not touch the sample needle.
 - Sample may slop from tube without cap and cause biological infection. Operator must be careful when handle it.
-

- Please make sure the blood tube do not place upside down when load them,or it will caused blood tube broken and biological infection
- Please make sure the blood tube put in right adapter before test,or it will caused blood tube broken and biological infection
- Blood tube broken may cause personal injury or or biological infection,Operator should be careful and not broke blood tube when load to rack or take blood tube from the rack.
- Clothes,hair,hand and other body part should keep distance from machine running parts to avoid hurt.
- Reagent will stimulate eye,skin and mucosa.Operator who have access to those things should comply with laboratory safety operation regulations and wear protective cloth(protective clothing, gloves and so on).
- Once skin touch reagent,please wash immediately with plenty of water and have medical treatment if need.Once eye touch reagent,please wash immediately with plenty of water and have medical treatment.

CAUTION

- Do not use disposable goods repeatedly.

CAUTION

- Please use proper vaccum blood tube,centrifuge tube,capillary tube and other disposable goods according to the manufacturer.
- When change sample mode from predilute to whole blood,machine will process the procedure automatically and show progress bar.

1. Enter QC chart

Click " Whole blood QC " ,enter L-J QC setting interface as following picture.

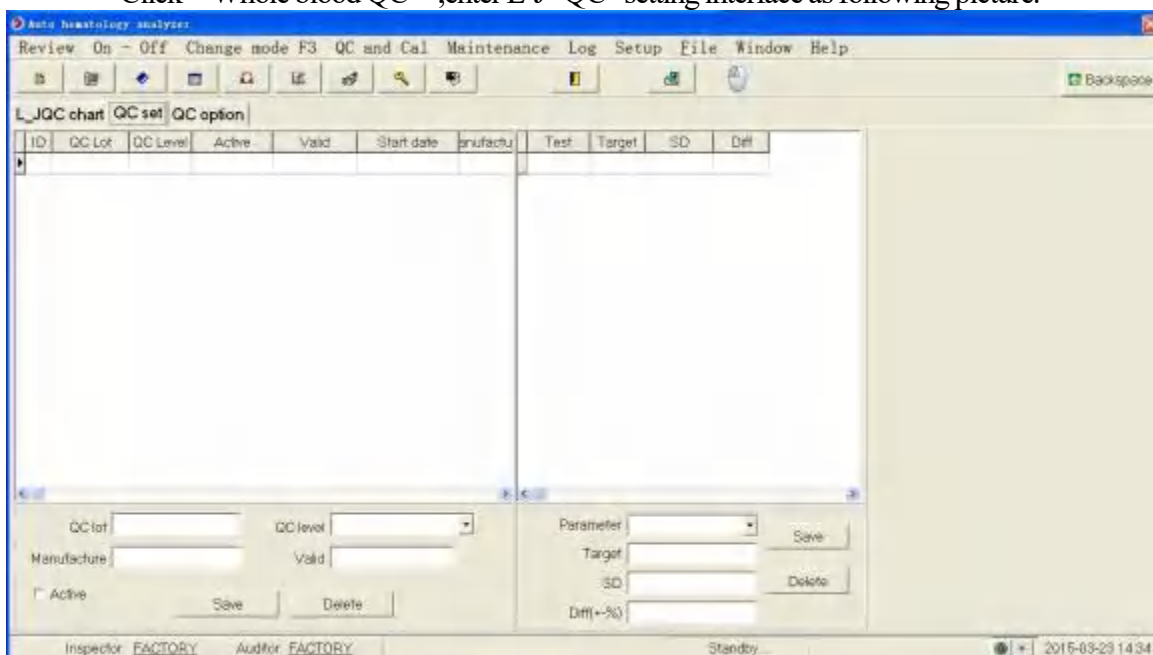

1. Set Control parameter according to user manual.Click " Save " .

-
2. Select reagent item(can be several).Click " Save " .
 3. Select control file number and the port will show relative information.
 4. Confirm if the control level is in accordance with control file.
 5. Confirm the control is valid or not.
 6. Prepare the control going to be test according to the user manual.
 7. Process QC analysis.
 - 1) Confirm test mode is " Whole blood " mode and machine guiding light is in green.
 - 2) Shake the control as following picture to mix it fully.

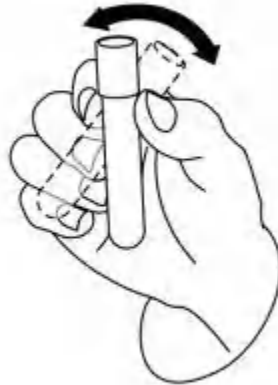

8. The result will show in current interface when test finish and save to current control file.

CAUTION

- Each control file can save not more than 300 control results
-

9. Continue control test as above steps again if need.

Predilute QC analysis

The test steps is same with whole blood QC analysis.

8.2.3 QC result review

Operator can review QC test result in following methods.

QC chart

QC result list

QC chart review



-
- All things(Sample,control,calibrator,reagent and waste) and area that touched by those things have potential risk of biological infection.Operator who have access to those things and area should comply with laboratory safety operation regulations and wear protective cloth(protective clothing, gloves and so on)
-

- Enter into QC interface
- Choose QC Lot number

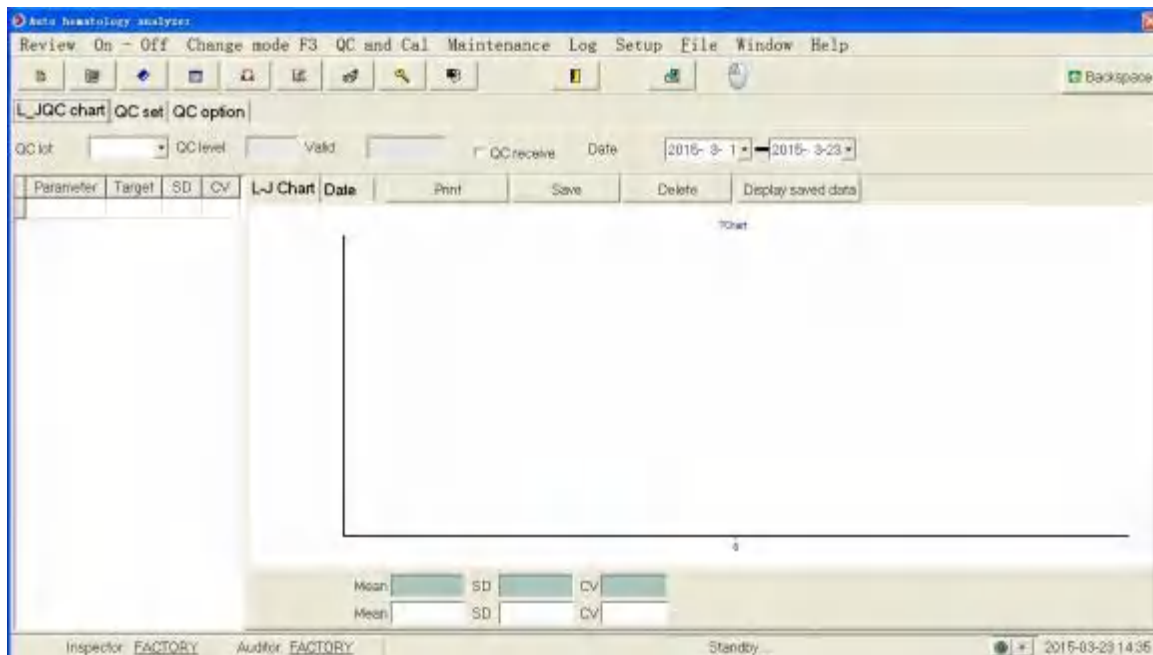

- Select to review " L-J QC chart " or " Statistics "

Delete

For " admin " user,operator can delete QC results as following steps.

1. To delete one QC result,click the result.
2. Click " Delete " ,software will prompt 4 kinds of choice.
3. Click those date going to be delete.
4. Click " ok "



- Delete record will record in log
-

Print

Print QC result list as following steps

1. Click " Print " to enter print preview interface.
2. Check it and print.

Statistics storage



- Copy data base have the limit of user permission.If operator want to backups data base,please log in in " admin "
-

- Click " Save " and show following window.

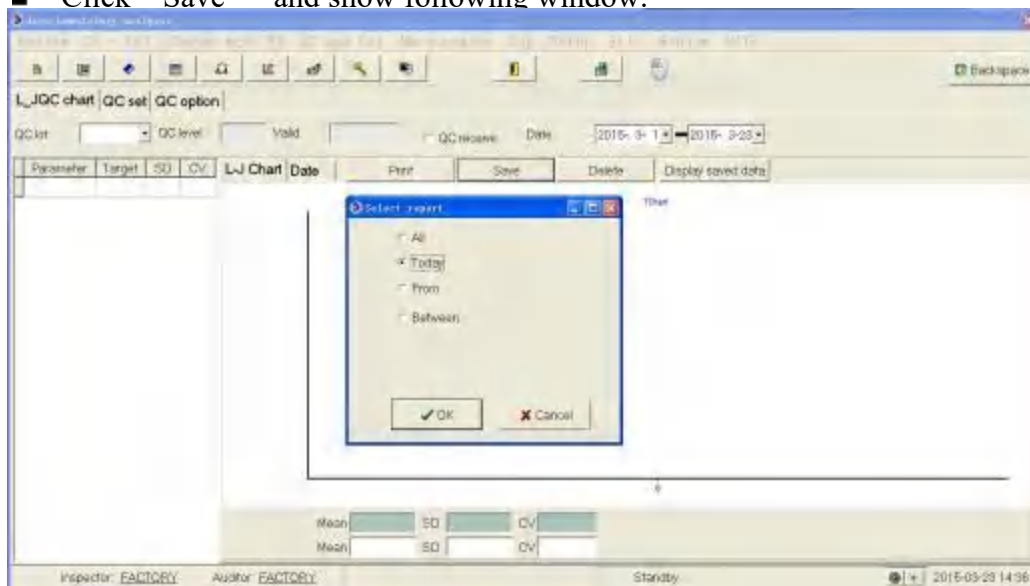

- Select the date

- Click " OK" and show following window for save.

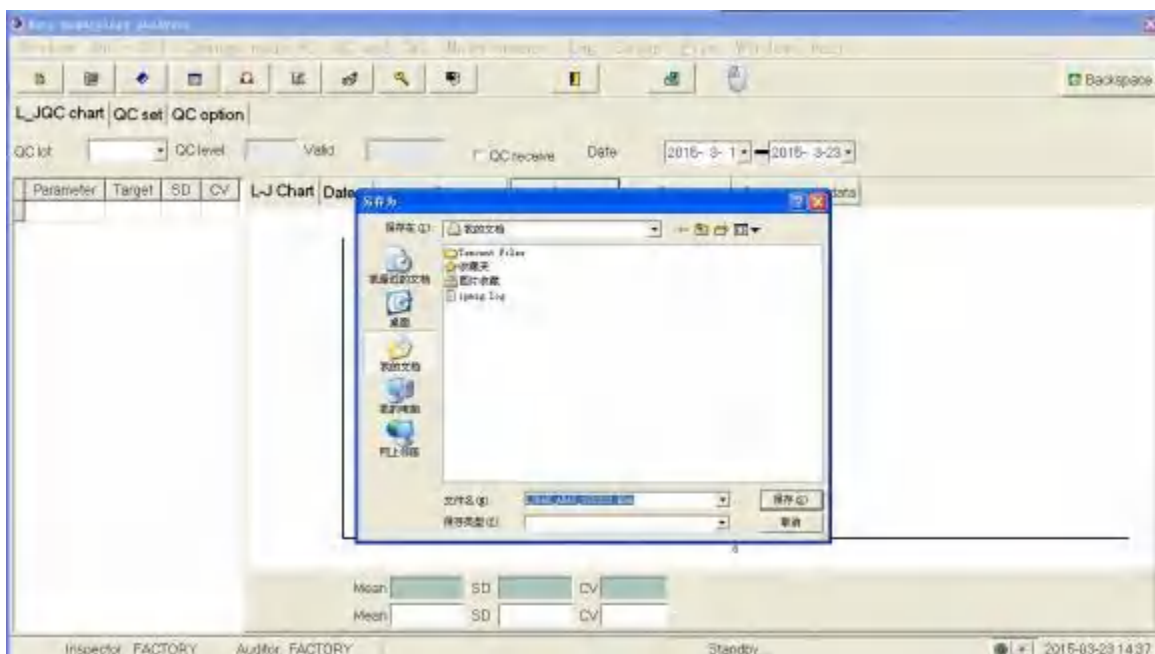

Enter file name for save.

Load in data

If operator want to load in QC information and data, please operate as following steps.

1. Click " Display Saved data " and show following window.

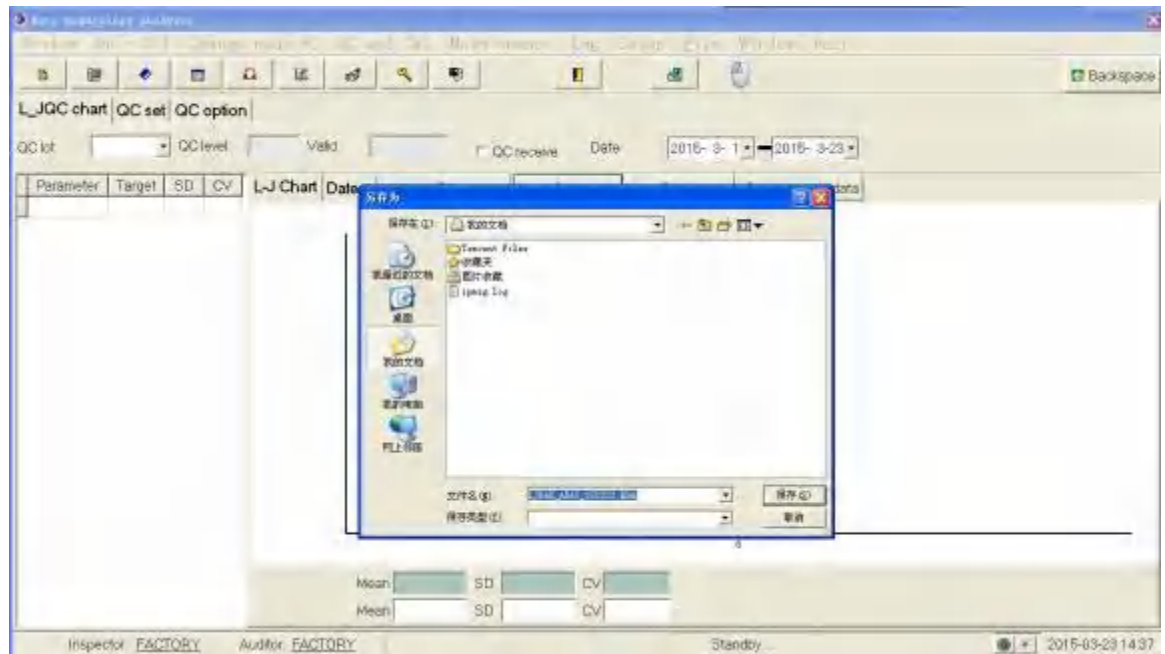

2. Select the file
3. Click " Open "

8.3 Floating Mean Value

X-B method of floating mean value is used to monitor the performance of the analyzer, by detecting the parameters stability of the red blood cell, such as MCV, MCH, MCHC. It belongs to quality control that without quality control material, used to monitor the performance of analyzer just like what the quality control material do. They can separately monitor the performance of different aspects of the analyzer, and can not replace each other.

When the sample quantity is greater than 100 per day, it is recommended to use XB quality control. This quality control method requires using random samples, and therefore it does not apply to the sample classified by disease. The given reference value and the upper and lower limits constitute a reference range. Observe the trends of the quality control results in the reference range.

The analyzer realize X-B quality control at MCV, MCH, MCHC. The sample number of each group that performed numerical analysis with X-B can be set from 20 to 200. The samples are from the normal count results of the analyzer, do not distinguish between whole blood and pre-dilution mode. The analyzer can save up 500 X-B quality control results at most. When the stored QC results exceeds the maximum number, the new quality control results will overwrite the oldest result.

8.3.1 Edit QC



- All items (samples, quality control material, calibrators, reagents, waste, etc.), and the area in contact with these substances have potentially dangerous of infectious organisms. When touch the related items and regional area in the laboratory, the operator should comply with the laboratorial requirements for safe operation, and wear personal protective equipment (such as laboratory protective clothing, gloves, etc).
-



- Only administrator-level users have permission to conduct quality control editing.
 - For the quality control file with quality control results, if it is saved after you modify the reference value or deviation limit of the parameters, resulting in the change of the reference value and the deviation limit, the changed data will be highlighted in yellow color background, and credited to the system log.
-

Before analyze a new batch quality control material, need to set up quality control file for each batch quality control material, can edit information as either of the following methods:

- Click on "quality control and calibration" in the main menu.
- Select "floating mean value" to enter the following interface.

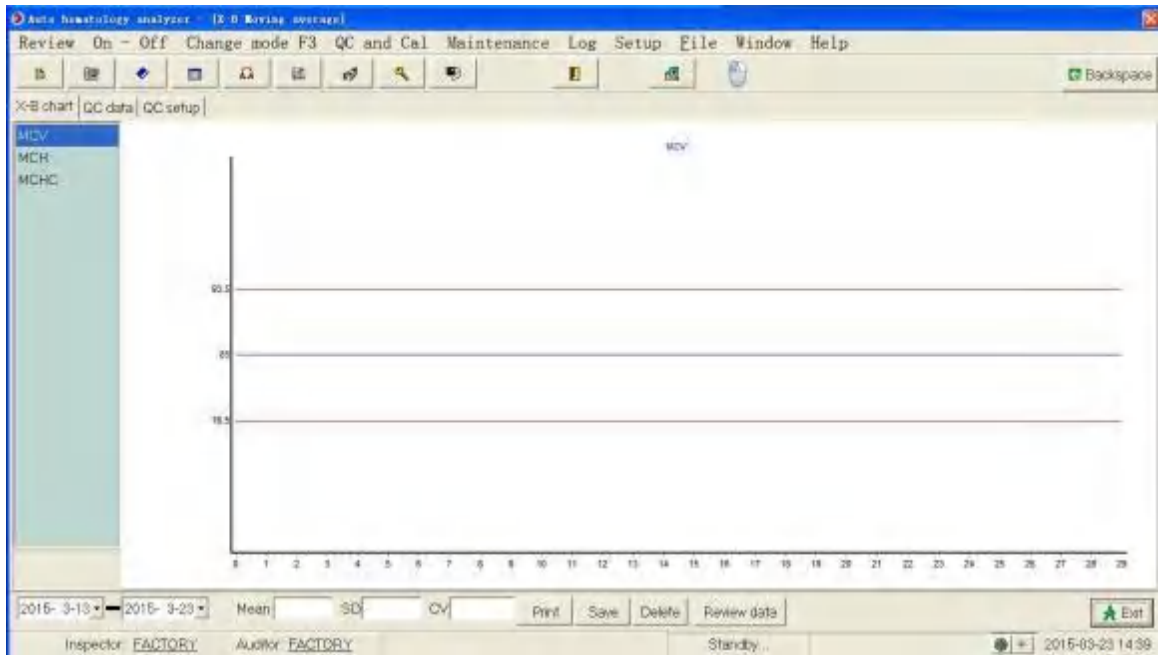

Click QC Setup

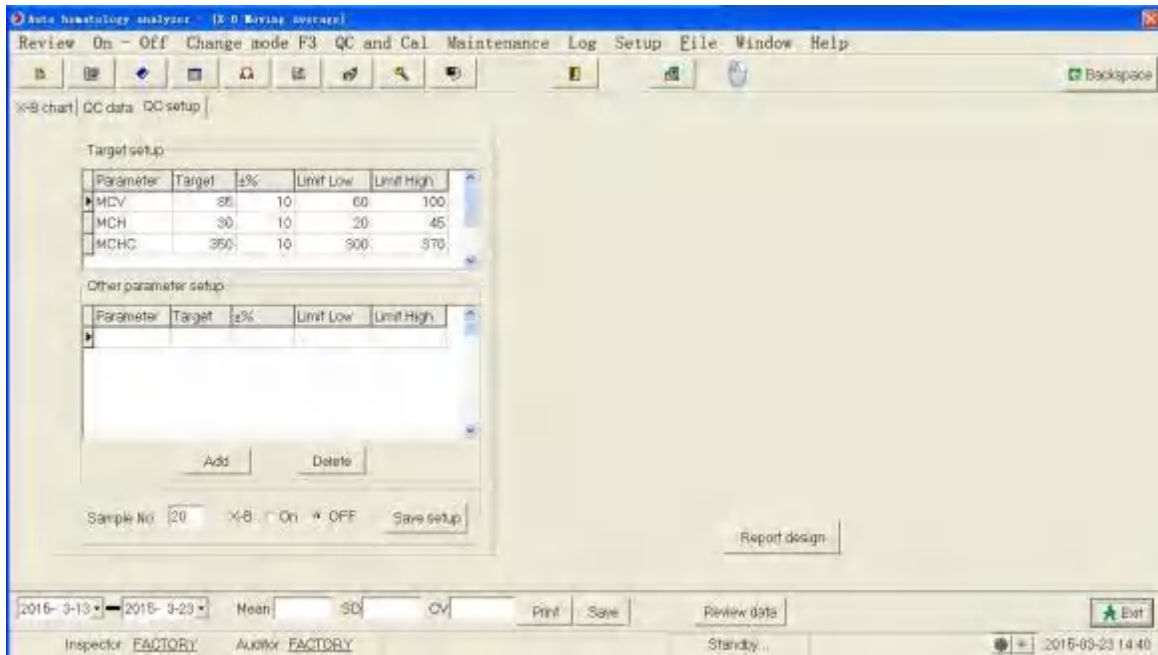

Setting according to the QC information provided by the manufacturers of quality control material.

Enter X -B control chart interface.

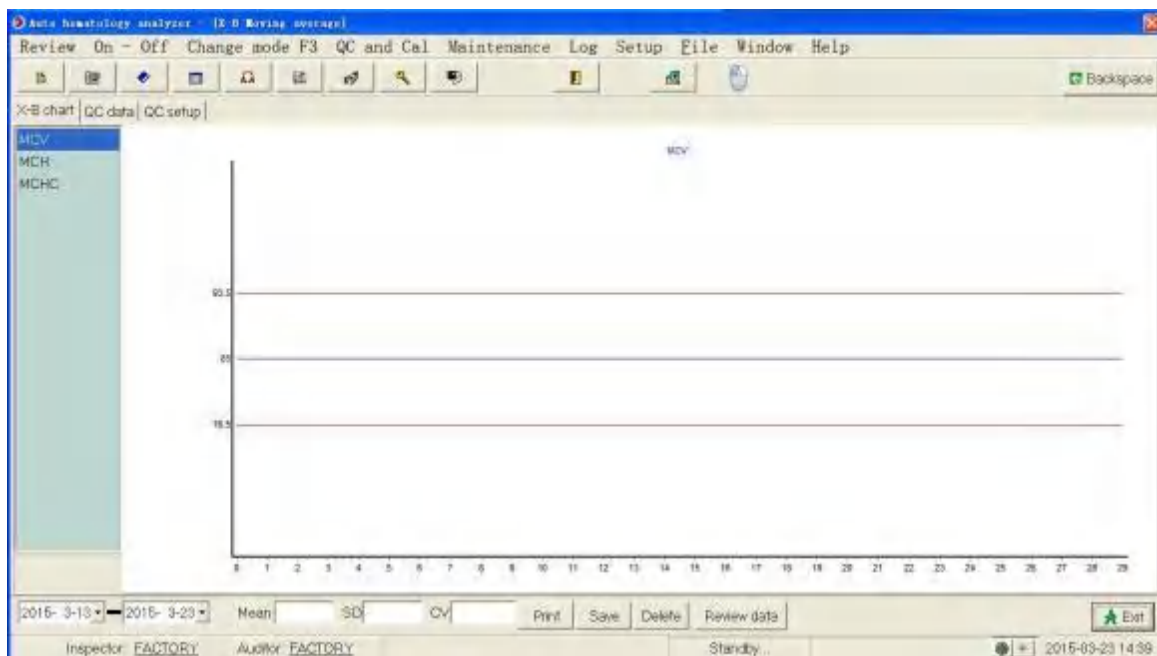

Sames as the QC of whole blood, you can realize the functions of "print", "Archive", "Delete" and "Display archive data".

Chapter 9 Calibration

9.1 Introduction

Calibration is the bias correction factor of blood samples under the specified conditions. It is used for obtaining accurate measurement result. To get an accurate blood analysis result, should calibrate the hematology analyzer, according to the procedures indicated in this chart if needed.

The analyzer provides three ways of calibrations: manual calibration, calibrator materials and calibration of new blood.

Can calibrate all or part of the parameters of WBC, RBC, HGB, MCV, PLT.

CAUTION

- Only the operator privileged as administrator can calibrate.
 - The operator should use our calibration materials and reagents, operating and storing in strict accordance with the calibration and reagents instructions.
 - Only the calibration counting operated in the calibration screen is Calibration .
 - Calculating repeatability should also be included in the calibration step.
-

9.2 When to calibrate

The analyzer is already calibrated before shipped from factory. No need frequent calibration, since the performance of the analyzer is stable. The operator still need to calibrate the analyzer, in following four conditions:

- ☞ Before the first use;
- ☞ After replacing major components;
- ☞ When de-sterilize the analyzer whose host is not used for long time;
- ☞ Check the daily quality control data every day, to see whether there is a significant deviation

CAUTION

- The measurement data can be used as valid data only after the analyzer is calibrated.
-

9.3 How to calibrate

9.3.1 Preparation

Before calibration, please check the following steps to confirm the analyzer's background range, reproducibility and carryover rate are within the range specified in the instructions. Otherwise should find out the problems until the problems are solved and then determine whether calibration is required. If the problems can't be resolved, please contact DRAWELL service department.

1. Check the host and reagents, to ensure the reagent amount is sufficient to complete the entire calibration process. If the reagents are run out during the calibration, need re-calibrate
2. Perform background detection. If "background is unnormal" appears on the bottom of the screen, please refer to Chapter 11, "Troubleshooting" for processing, to ensure that the test results of background meet the requirements (background range is indicated in Appendix B specification)

Count continuously 11 times, With the control material of mid-value in the whole blood - continuous -CBC + DIFF, select the counting result from second to 11th, check the repeatability of counting results from second to 11th in the "review list" screen, to ensure it is within the predetermined range in the following table

Parameters	Range	(CV) Repeatability of the whole blood sample	(CV) Repeatability of the pre-dilute sample
WBC	$(4.0 \sim 10.0) \times 10^9/L$	$\leq \pm 2.0\%$	$\leq \pm 4.0\%$
RBC	$(3.5 \sim 5.5) \times 10^{12}/L$	$\leq \pm 1.5\%$	$\leq \pm 3.0\%$
HGB	$(110 \sim 160)g/L$	$\leq \pm 1.0\%$	$\leq \pm 2.0\%$
MCV	$(80 \sim 100)fL$	$\leq \pm 0.5\%$	$\leq \pm 1.0\%$
PLT	$(100 \sim 300) \times 10^9/L$	$\leq \pm 4.0\%$	$\leq \pm 8.0\%$

3. Count the Quality control material of high value three times, then immediately count with the matching dilution three times. Then calculate the carryover rate, according to the following formula.

$$\text{Contamination rate (\%)} = \frac{\text{The first low sample results} - \text{The third low sample results}}{\text{The third high sample results} - \text{The third low sample results}} \times 100\%$$

The result should meet the following requirements:

Parameter	Carryover rate
WBC	$\leq \pm 0.5\%$
RBC	$\leq \pm 0.5\%$
HGB	$\leq \pm 0.5\%$
PLT	$\leq \pm 0.8\%$

4. We recommend the operator to establish a record file and make a record sheet to file them. Following items are recommended to be included in the record sheet

Date, the source of calibration material, batch number and the reference value, the background detection value

- 
- All items (samples, quality control material, calibrators, reagents, waste, etc.), and the area in contact with these substances have potentially dangerous or infectious organisms. When touching the related items and regional area in the laboratory, the operator should comply with the laboratory requirements for safe operation, and wear personal protective equipment (such as laboratory protective clothing, gloves, etc.).
-

CAUTION

- Sampling needle is sharp, and it may have hazardous materials contaminated with biological pollution. Should operate the analyzer with caution and do not touch the sampling needle.
 - The reagent can irritate the eyes, skin and mucous membranes. When touching the reagents and related items in the laboratory, the operator should comply with laboratory safety regulations and wear personal protective equipment (such as laboratory protective clothing, gloves, etc.).
 - Once the reagent contacts with skin, please wash immediately with plenty of water. Should seek medical treatment if necessary; Once the reagent contacts with eyes, rinse immediately with plenty of water and seek medical treatment.
 - Must maintain a certain distance between clothes, hair, hands, etc. and the moving parts, to prevent injury by the moving parts.
 - The operator is obliged to comply with the discharge and treatment regulations of the area and the relevant country for reagents, waste, waste samples, consumables and so on.
-

CAUTION

- Do not reuse disposable items.
-

CAUTION

- The operator shall adopt the quality control material and reagents designated by the Company, use and store in strict accordance with the instruction of quality control material and reagents.
 - Should use vacuum blood collection tubes, centrifuge tubes, capillary and other disposable goods specified by the manufacturer during blood sampling.
 - Please use the vacuum blood collection tube of sizes complying with that recommended in the appendix.
-
-

9.3.2 Manual Calibration

Complete the calibration manually as following steps:

1. The operator clicks the "Menu" button, select "Calibration", enter the calibration coefficients interface. It is default that whole blood and prediluted mode calibration coefficient will display on the Calibration coefficients interface

CAUTION

- If the operator log in as a normal user, he can only view the calibration coefficients on the current interface, and can not realize calibrated operation. To calibrate the analyzer, you should log off the current user, and then log in as administrator

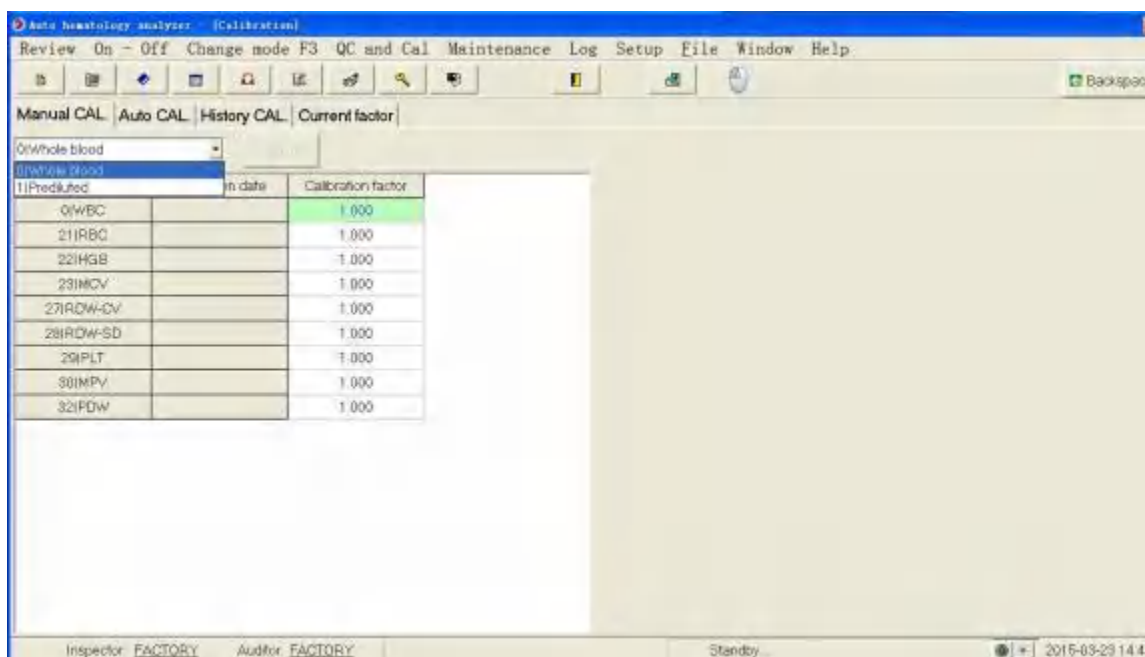

2. The operator enter the "calibration coefficient" interface to view calibration coefficients, use the following formula to calculate the new calibration coefficient of the various calibration parameters

$$\text{the new calibration coefficient} = \frac{\text{the current calibration coefficient} * \text{the reference value}}{\text{Measurement mean value}}$$

For example: Suppose the WBC reference value of a calibration object is 8.4, the calibration coefficient of the current whole blood mode is 0.989.

Measure the WBC parameters of the calibration object 11 times in whole blood mode, adopt the results from the second to 11th(n = 10), and the results are 8.1,8.0,8.1,8.1,8.3,8.3,8.2,8.0, 8.1, 8.3, get repetitive index CV = 1.5%, Mean = 8.16,meeting the requirements, and the measurement mean value is valid.

Calculate the new calibration coefficient

$$\text{New calibration coefficient} = \frac{0.989 * 8.4}{8.16} = 1.0181$$

If the calculated reference parameter of calibration coefficients is out of the valid range (75.00% ~ 125.00%), the calibration coefficient is invalid. In such cases, the operator need to find out the reason (the sample is not well mixed or incorrect operation, etc.), re-calibrate and calculate calibration coefficients again.



- The calibration coefficient input should be within the range of 75.00% ~ 125.00%, and only two decimal places are saved.

3. After get the new calibration coefficients,enter them into the calibration coefficients cells requiring calibration parameters.

4. Click on —Save.

9.3.3 Auto calibration

- Click on "Calibration" in the "Quality control and calibration" of the menu bar, or click on "Calibration" on the toolbar,to enter the following interface:

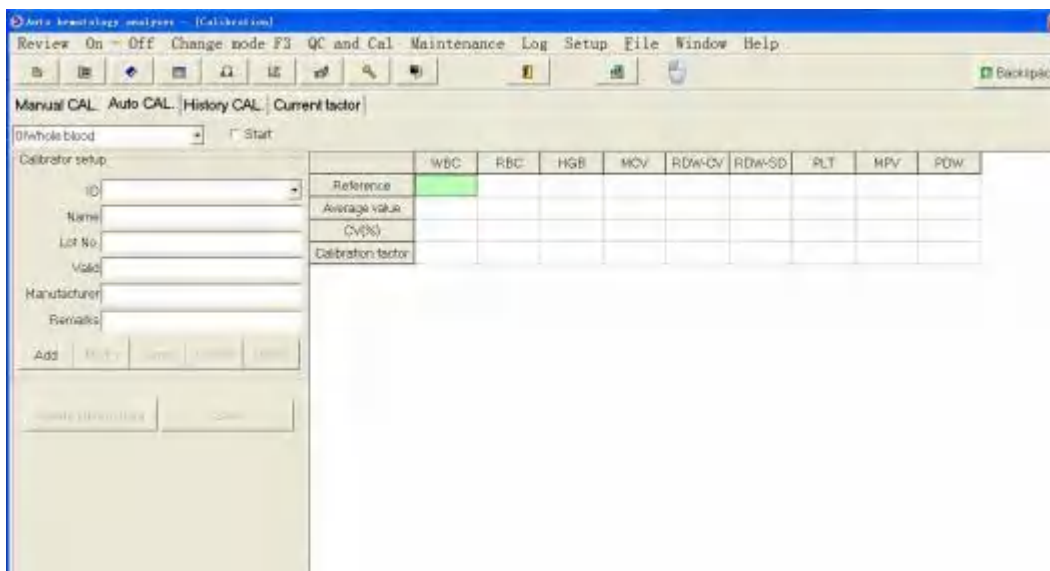

Click on "Automatic calibration" to enter the following interface:

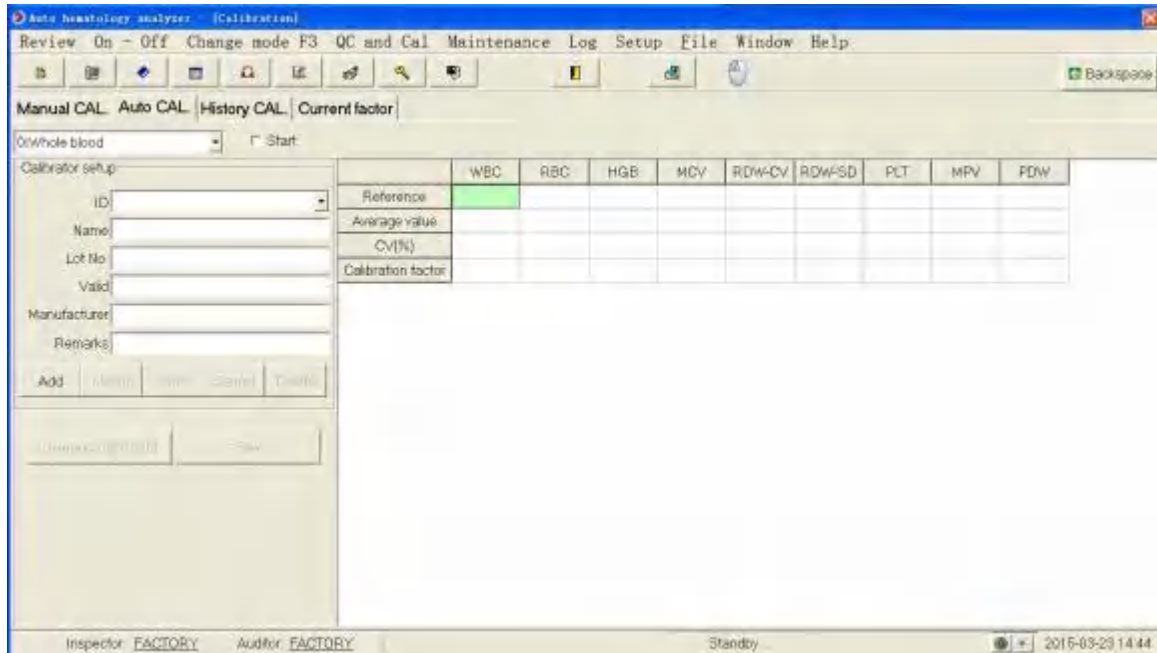

- Click —Add—. Set sample information (name,reference value,etc.),according to the sample.
- Click —Start—
- Switch the test mode,start tesing sample
- Click —Save—,after finishing the test.(Standardized coefficients is greater than or equal to 0.7, Less than or equal to 1.3)

9.3.4 Calibration

Click —Calibration— —History Calibration— to enter the calibration history query.

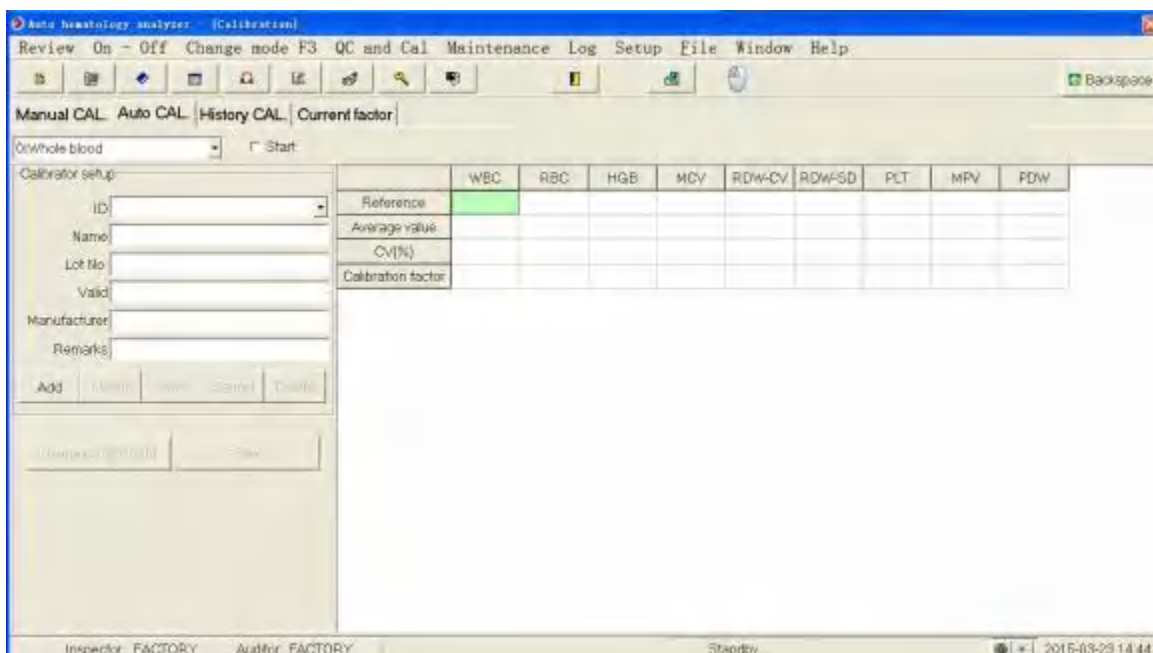

The calibration history can be displayed.

Chapter 10 Service

10.1 Introduction

To ensure the analyzer with accurate, effective and good performance, please operate daily maintenance for analyzer, according with the instruction which mentioned in this chapter. The analyzer provides a number of maintenance function, convenient for the operator to finish maintenance.

This chapter introduces the maintenance function and treatment measures when fault alarm appear.



- There are potential infectivities on all parts surface of the analyzer, should take safety protection measures during the operation and repair.



- Improper maintenance may damage the analyzer. The operator must maintain accordance with the guidance in the user-manual.
 - If you have some problems that not explained clearly in the user-manual, please contact the after-sales service department of DRAWELL science corporation for maintenance suggestions from the designated professional personnel.
 - Should use the spare parts provided by DRAWELL Science Corporation during analyzer maintenance. For any questions, please contact our after-sales service department.
 - Please don't touch the sharp sampling needle.
-

10.2 Maintenance

10.2.1 Change reagent

WARNING

- The reagent can stimulate the eyes, skin and mucous membrane. Operator should comply with the laboratory safety operation regulations, and wear personal protective equipment (such as laboratory protective clothing, gloves, etc.), when touch reagent and related items in the laboratory.
 - Once the skin is touched with the reagent, should wash immediately with plenty of water. If necessary, please ask doctor for treatment. Once the eyes are touched with the reagent, should rinse immediately with plenty of water, and receive medical treatment.
-

CAUTION

- Please keep the reagent standing for a long time until it is steady before use.
 - To ensure the background value is in the normal range and prepare sample analyse, should do background test after changing diluent, detergent and lyse, etc.
-

Should change reagent under following situations:

Total bucket/total bottle new reagent is changed

It is suspected that the reagent stored in the pipeline is polluted

- It is suspected that there are bubbles in the pipeline

Click "care and maintenance"---"Reagent guide and maintenance" in the main menu. Following window display:

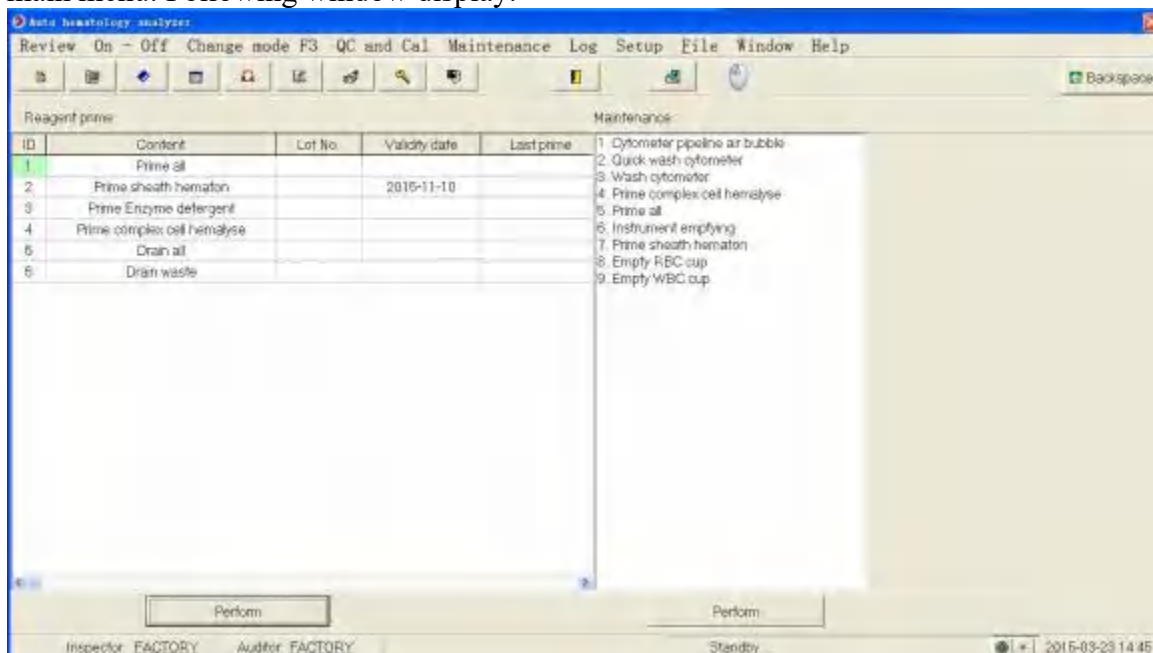

Users can change following reagent:

Sheath Hematon

Enzyme detergent

Complex Cell Hemalyse

CAUTION

- The violent vibration or collision of the diluent bucket with other object is not allowed, otherwise may lead the alarm unreliable
- Please change the diluent bucket according with following procedures:
 - 1) stuck the bucket mouth with the supporting board of dilution bucket, as follow;
 - 2) Insert the dilution bottle cap assembly (as shown below) vertically into the diluent bucket, and screw the bottle cap tightly. Otherwise it may lead to unreliable alarm

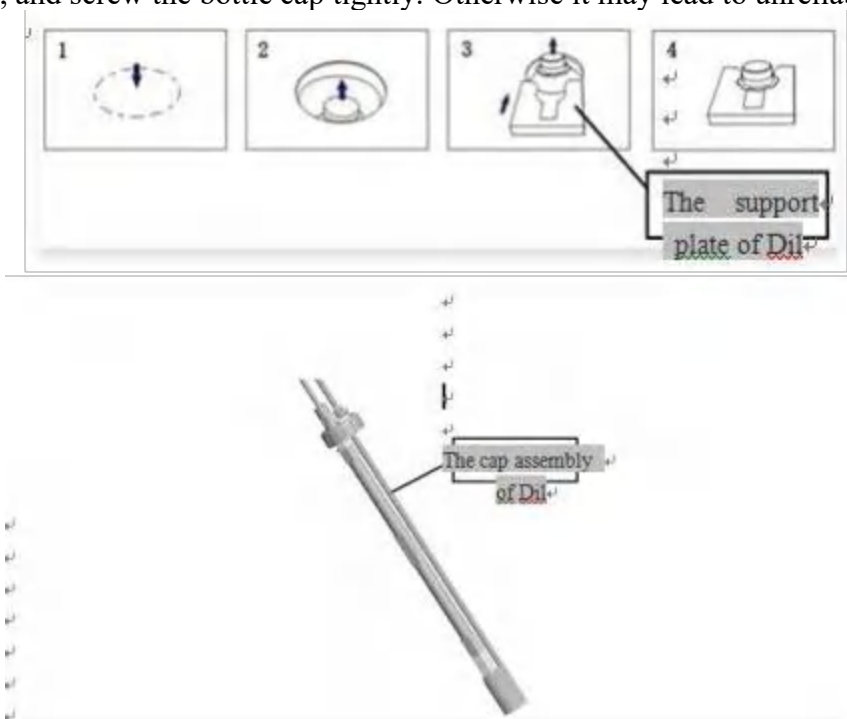

The procedures of changing reagent are as below:

1. When the reagent is running out, alarm icon of each reagent will pop-up in the the test interface. Please enter Lot No. and expiration date of the new reagent in the dialog box.

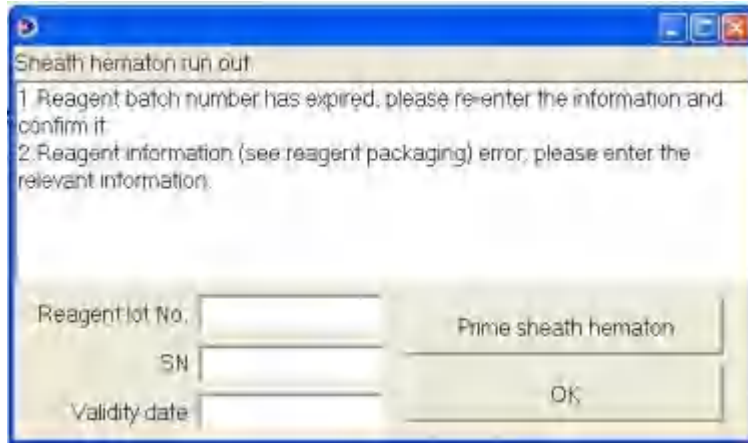

2. If the reagent Lot No. is expired, alarm icon of each reagent will pop-up in the the test interface. Please enter Lot No. and expiration date of the new reagent in the dialog box.

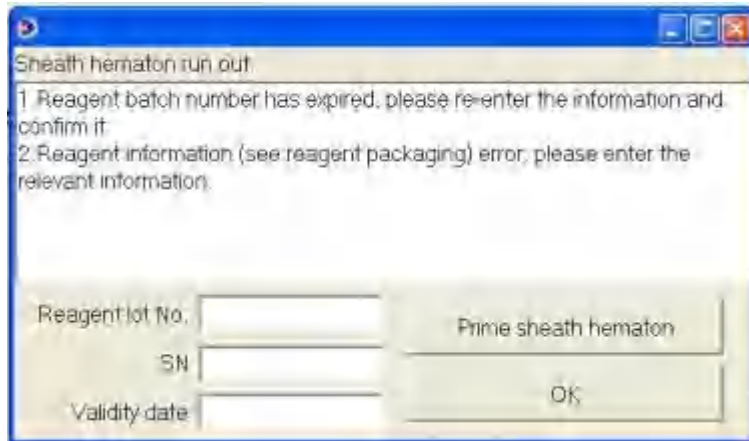

CAUTION

- If the operator need to replace with a new bottle of reagent, at this time, please enter the new Lot No. and expiration date. Analyzer will save the new Lot No. and expiration date, and amend the expiration date of opening the bottle automatically. Press "confirm" button to complete the operation. If there are air columns or air bubbles in the reagent pipelines, "guide reagent" is suggested.
- The expiration date is not allowed to be blank.
- When the reagent Lot No. is expired, above information window will pop up, please re-enter the relevant information and confirm it, this operation can be without "guide reagen

3. After the replacement, click "OK" button to close the dialog box

4. When reagent management is under care and maintenance, can open three reagents: guide Sheath Hematon, guide Enzyme detergent and guide Complex Cell Hemalyse

10.2.2 Counter Cleaning

Need to clean corresponding components under following conditions:

Please clean the WBC pool,if the brackground result of WBC and (or) HGB is beyond the brackground range.

Please clean the RBC pool,if the result of RBC and (or) PLT is beyond the brackground range.

Please clean the DIFF pool,if there are a lot of particles in the scatter plot of brackground result.

Please clean the flow chamber,if there are a lot of particles in the scatter plot of brackground result,or the effect of WBC classification is not good

Please clean the sample probe,if it is dirty.

Click "care and maintenance"--"counter maintenance" in the main menu to enter into following interface:

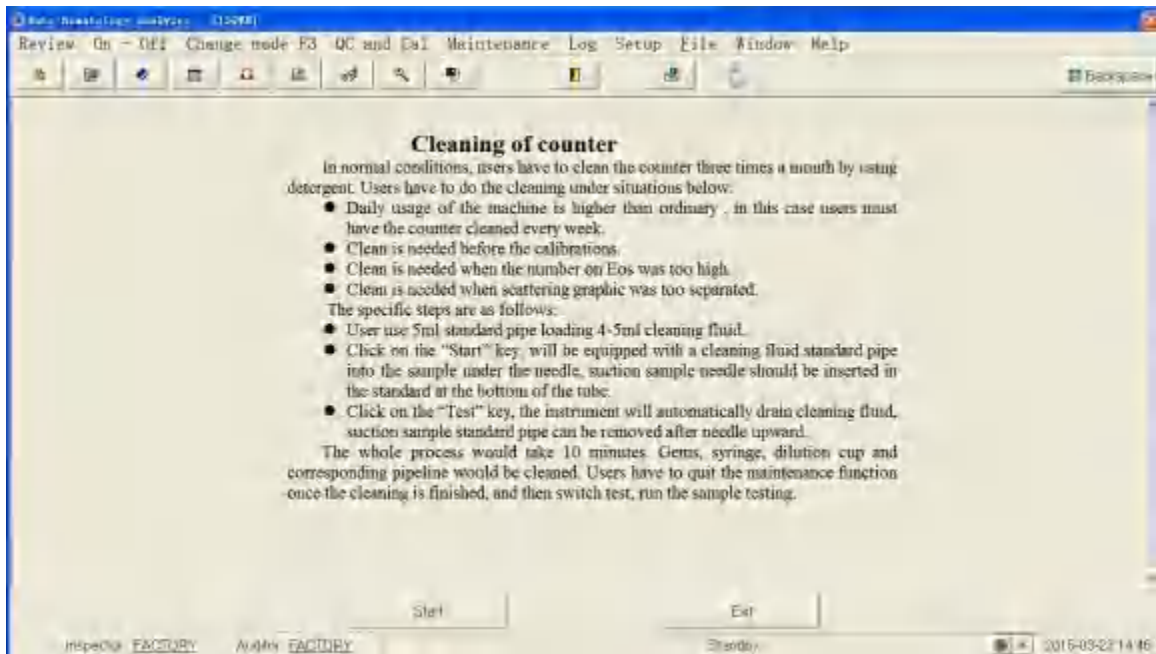

Please clean following components:

WBC cup

RBC cup

sample needle

counter

📁 corresponding pipeline

It takes about 10 minutes to finish the entire cleaning. The washing steps are as follows:

1. Click start
2. Insert the sample probe into the counter detergent
3. click the button
4. The analyzer clean automatically

10.2.3 Aperture cleaning

Please backlash clean the aperture, if it is blocked.

Click "care and maintenance"--"Reagent guide and maintenance" in the main menu to enter into following interface:

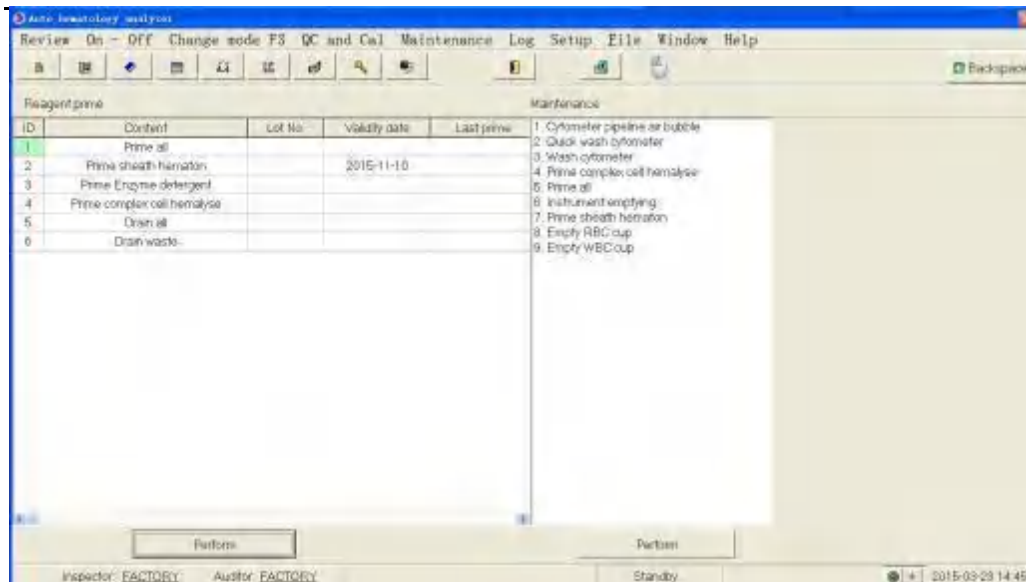

Steps are as follow:

1. click —2.fast counter cleaning
2. click —execute maintenancel,follow window pop out

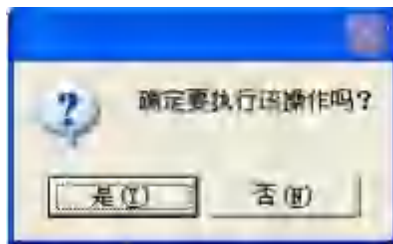

3. Click —yes. The analyzer start maintenance automatically

10.2.4 Eacuation

Click "care and maintenance"--"Reagent guide and maintenance" in the main menu to enter into following interface:

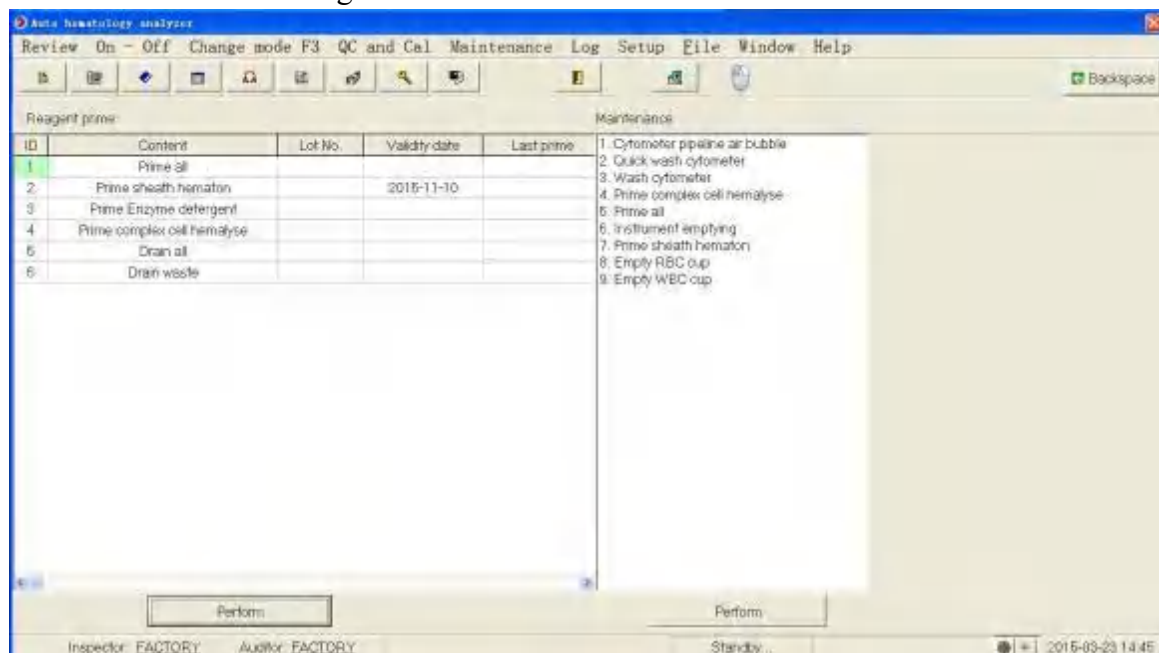

Steps are as follow:

1. Click —6.pipeline evacuationl
2. click —execute maintenancel, follow window pop out

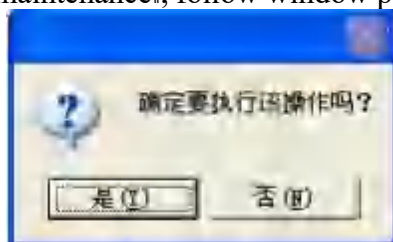

3. Click —yesl .The analyzer start maintenance automatically

10.3 Diary query

10.3.1 Alarm

click —Diary query|--"Alarm" in the main menu, follow window pop out

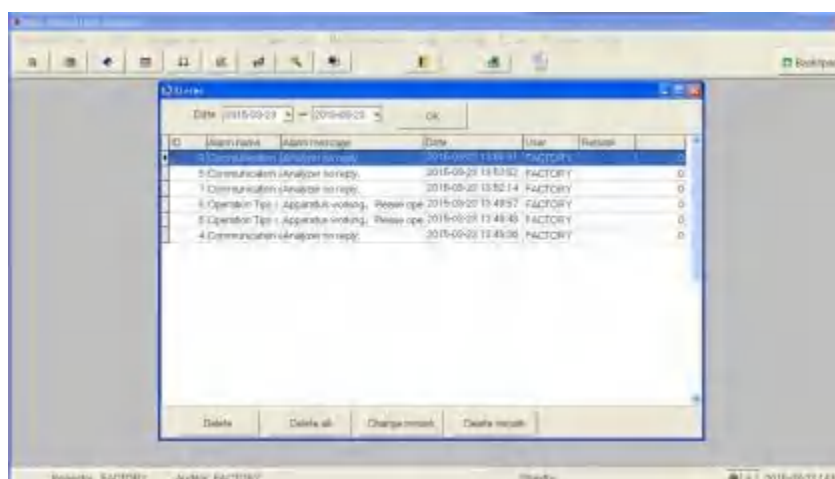

Can check the alarm situation, "Delete", "Memo" and "Delete Memo".

10.3.2 Reagent

Click —Diary query|--"Reagent" in the main menu, follow window pop out:



Can check the reagent situation, "Delete", "Memo" and "Delete Memo".

10.3.3 Mintenance

Click —Diary query|--"Reagent" in the main menu, follow window pop out:

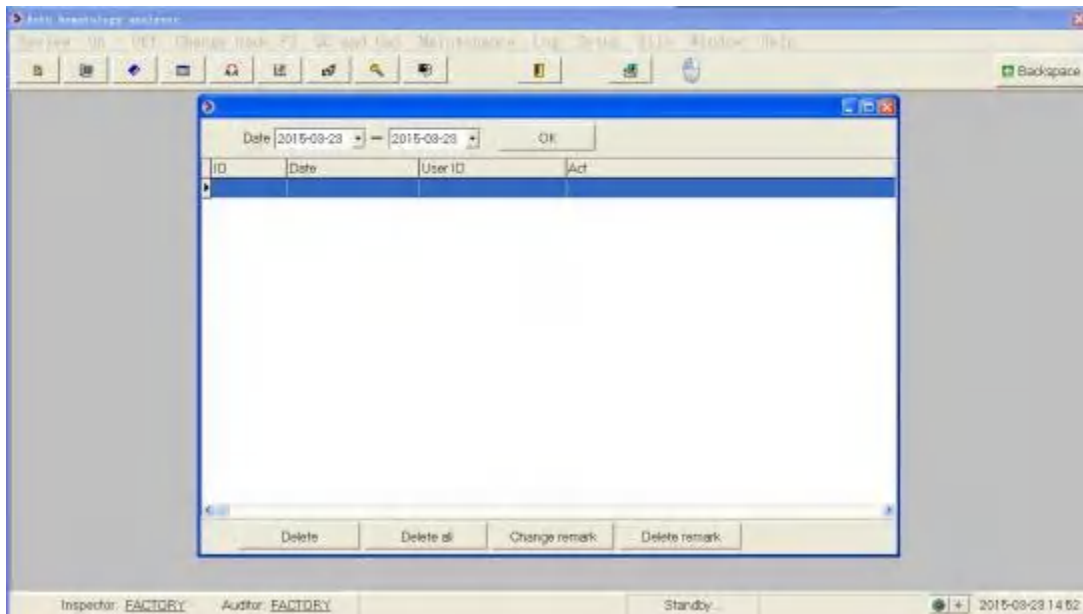

Can check the maintenance situation, "Delete", "Memo" and "Delete Memo".

10.3.4 Diary operation

Click —Diary query|--"Reagent" in the main menu, follow window pop out

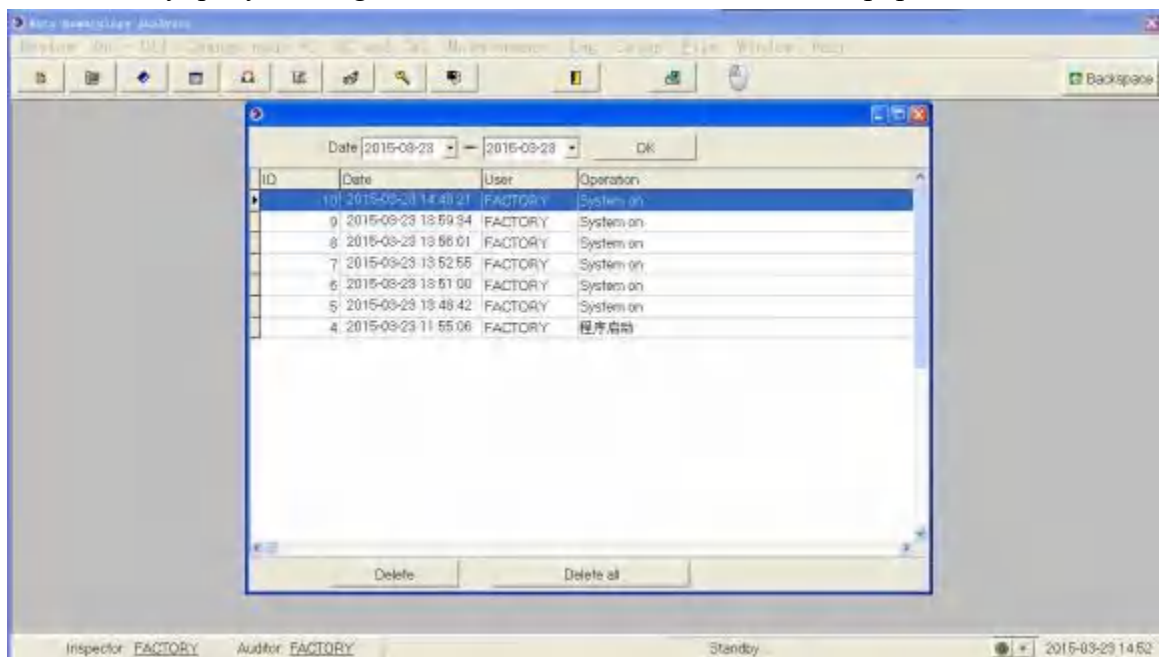

Can check the diary situation, "Delete", "Memo" and "Delete Memo".

Chapter11 Trouble shooting

11.1 Introduction

This chapter introduce the possible fault and provide appropriate treatment method.

CAUTION

- The manual does not belong to the service manual, is only for the user to operate the analyzer when the fault alarm arise.
-

11.2 Error information and treatment

During using the analyzer, if an abnormal condition is detected, a failure dialog box will automatically pop up in the software interface, while the host will sound with an alarm.

According to the fault level from high to low, the background color of the fault information area were red, orange, blue and green by order.

- Red: the fault is fatal. If such failure occurs, the host terminate the current operation immediately, and prohibit any other operations.
- Orange: the fault is forbidden. If such failure occurs, the host terminate the current operation immediately.
 - Blue: the fault is restricted. If such failure occurs, the host can continue to perform the current operation, but restricted other correlative operations related with the failure.
 - Green: that fault is reminder. After such failure occurs, the host can continue to perform the current operation, and doesn't limit any other operations.

Chapter 12 Edit Report Template

12.1 Introduction

The operator can modify the default template provided in the terminal software, and customize template format. After customize and save the new template, the operator can select the user-defined template in the print settings. When printing, the terminal software will call the user-defined template for printing, realizing the function of printing the report template defined by the operator.



- Normal users do not have permission to modify the report templates.
-

12.2 Editing Print Templates

When the operator login as administrator, click "System Settings" --- "Settings" on the main menu to Enter the "Report Settings." A window pop out as follows:

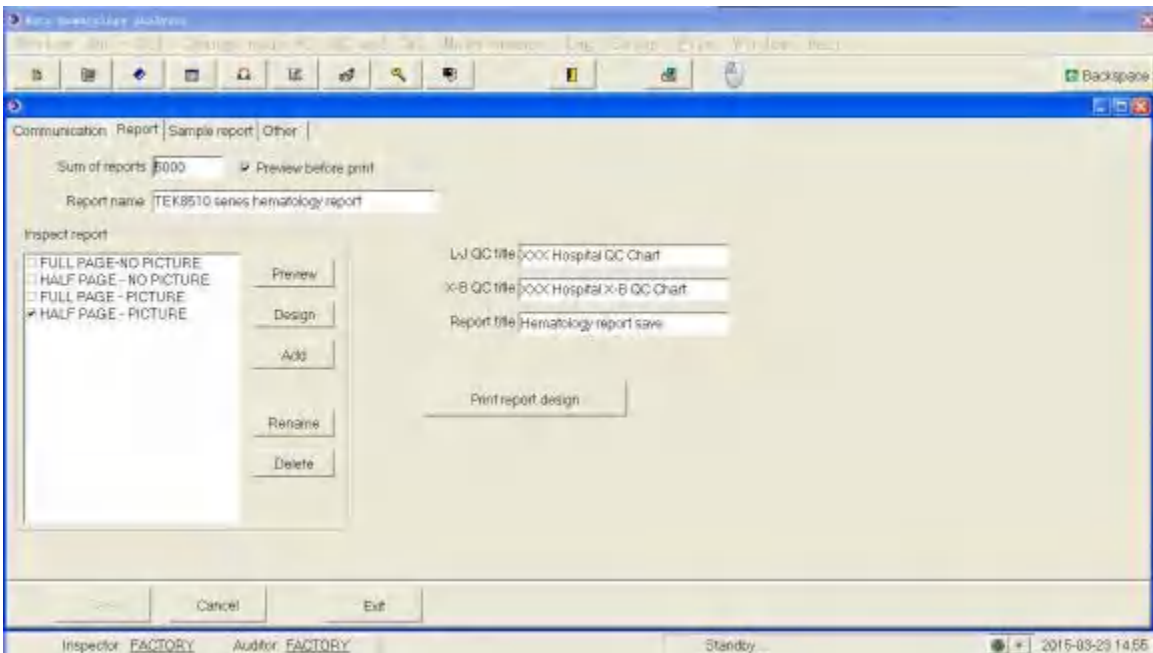

1. Click one of "Full Page without map", "half-page with map", "half-page without map" and "Full page with map" in "Inspection Report", for example: Click "half-page with map".
2. Click "design" to enter the following interface for editing.

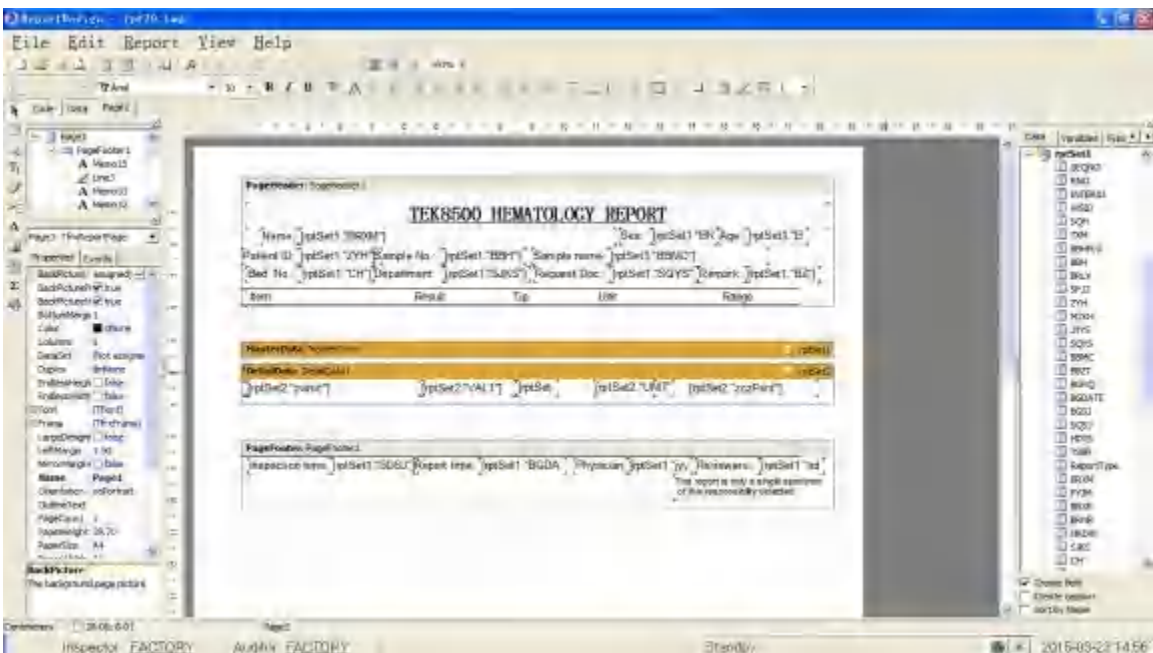

Appendices A License for manufacturing measuring instruments



GAN Issued 00000314 号

Appendices B Specification

B.1 Product Categories

According to Chinese medical equipment management categories,TEK8520 automatic hematology analyzer belongs to the blood analysis systems of clinical testing instruments (6840), management category is II.

B.2 Matched reagent for analyzer

Sheath Hematon
Complex Cell Hemalyse
Enzyme Detergent
Concentrate cleaner

B.3 Matched reagent for analyzer

Name	Acronym	Default unit
The number of white blood cells	WBC	$10^9 / L$
The number of neutrophils	Neu#	$10^9 / L$
The number of lymphocytes	Lym#	$10^9 / L$
The number of single nucleated cells	Mon#	$10^9 / L$
The number of eosinophils	Eos#	$10^9 / L$

The number of basophils	Bas#	10 ⁹ /L
The number of abnormal lymphocytes	ALY#	10 ⁹ /L
The number of huge immature cells	LIC#	10 ⁹ /L
The percentage of neutrophils	Neu%	%
The percentage of Lymphocyte	Lym%	%
The percentage of Single monocytes	Mon%	%
The percentage of eosinophils	Eos%	%
The percentage of basophils	Bas%	%
The percentage of abnormal lymphocytes	ALY%	%
The percentage of huge immature cells	LIC%	%
The number of red blood cells	RBC	10 ¹² /L
Hemoglobin	HGB	g/L
Hematocrit	HCT	%
Mean corpuscular volume	MCV	fL
Mean corpuscular hemoglobin	MCH	pg
Mean corpuscular hemoglobin concentration	MCHC	g/L
The standard deviation of Red cell distribution width	RDW-SD	fL
The coefficient of variation of Red cell distribution	RDW-CV	%
The number of platelets	PLT	10 ⁹ /L
Mean platelet volume	MPV	fL
Platelet distribution width	PDW	NO
Platelet hematocrit	PCT	%
Red blood cell distribution histogram	RBC Histogram	NO
Platelet distribution histogram	PLT Histogram	NO
WBC / basophils distribution	WBC/BASO Histogram	NO
White blood cells histogram	WBC	NO
Category scatterplot	Diff Scattergra	NO

B.4 Sample Characteristics

B.4.1 The required sample quantity for each analysis

Whole blood mode	10 μ L
Pre-dilution mode	20 μ L

B.4.2 Test rate

Test rate : ≥ 90 sample/hour

B.5 Performance indicators

B.5.1 The display range of main parameters

Parameters	Display range
WBC	$0 \sim 200.0 \times 10^9 / L^9$
RBC	$0 \sim 18.00 \times 10^{12} / L$
HGB	$0 \sim 300 g / L$
PLT	$0 \sim 2000 \times 10^9 / L^9$
HCT	0%~80%

B.5.2 Blank count

Parameters	Background range
WBC	$\leq 0.2 \quad 10^9 / L$
RBC	$\leq 0.02 \quad 10^{12} / L$
HGB	$\leq 1 g / L$
PLT	$\leq 10 \quad 10^9 / L$

B.5.3 Linear range

Parameters	Linearity range	Linearity error
WBC	$(0.0 \sim 10.0) \times 10^9 / L$	Not exceeding $\pm 0.30 \times 10^9 / L$
	$(10.1 \sim 100.0) \times 10^9 / L$	Not exceeding $\pm 5\%$
RBC	$(0.00 \sim 1.00) \times 10^{12} / L$	Not exceeding $\pm 0.05 \times 10^{12} / L$
	$(1.01 \sim 9.99) \times 10^{12} / L$	Not exceeding $\pm 3\%$
HGB	$(0 \sim 70) g / L$	Not exceeding $\pm 2 g / L$
	$(71 \sim 300) g / L$	Not exceeding $\pm 2\%$
PLT	$(0 \sim 100) \times 10^9 / L$	Not exceeding $\pm 10 \times 10^9 / L$
	$(101 \sim 1000) \times 10^9 / L$	Not exceeding $\pm 10\%$

B.5.4 Repeatability index

Test repeatedly 10 times to calculate the repeatability based on the conventional method, using a sample within the predetermined range

Parameters	Range	Accuracy
WBC	$(4.0 \sim 10.0) \times 10^9 / L^9$	$\leq \pm 2.0\%$
RBC	$(3.50 \sim 5.50) \times 10^{12} / L$	$\leq \pm 1.5\%$
HGB	$(110 \sim 160) \text{ g/L}$	$\leq \pm 1.0\%$
PLT	$(100 \sim 300) \times 10^9 / L^9$	$\leq \pm 4.0\%$
HCT	$35\% \sim 55\%$	$\leq \pm 0.5\%$
MCV	$(80 \sim 100) \text{ fL}$	$\leq \pm 0.5\%$

B.5.5 Carry-over rate

Parameters	Carry-over rate
WBC	$\leq \pm 0.5\%$
RBC	$\leq \pm 0.5\%$
HGB	$\leq \pm 0.5\%$
PLT	$\leq \pm 0.8\%$

B.6 Input and output devices



- Printers and other external devices must pass the mandatory certification CCC (S & E). Unqualified external device may cause the system not working properly and cause personal injury.
-

B.6.1 Keyboard and mouse

Wireless keyboard and mouse are standard configuration with instrument. The user can also use USB mouse and USB keyboard.

B.6.2 Barcode scanner (optional)

External Barcode scanner

B.6.3 Printer (optional)

External Laser printer/Inkjet printer, various printout formats and user-defined formats

B.7 Main machine interface

A network port

B.8 Power supply

	Voltage	Input power	Frequency
Main machine	~99V-242V	≤1000 VA	50Hz±1Hz

B.9 Sound pressure

The maximum sound pressure : 67.7 dBA



- Please be sure to store and use the analyzer under specified environmental conditions.
-

B.10 Working environment conditions

Environment temperature range: 10 °C ~ 35 °C

Relative humidity range : ≤90 %

Atmospheric pressure range : 70 kPa ~ 106 kPa

No frost, condensation, water seepage, rain, sunshine, etc.

B.11 Transport and storage conditions

Environment temperature range : - 10 °C ~ 55 °C

Relative humidity range : ≤95 %

Atmospheric pressure range : 500hPa ~ 1060hPa

B.12 Running Environment

Environment temperature range : 10 °C ~ 35 °C

Relative humidity range : ≤90 %

Atmospheric pressure range: 70.0 kPa ~ 106.0 kPa

B.13 Dimensions and weight

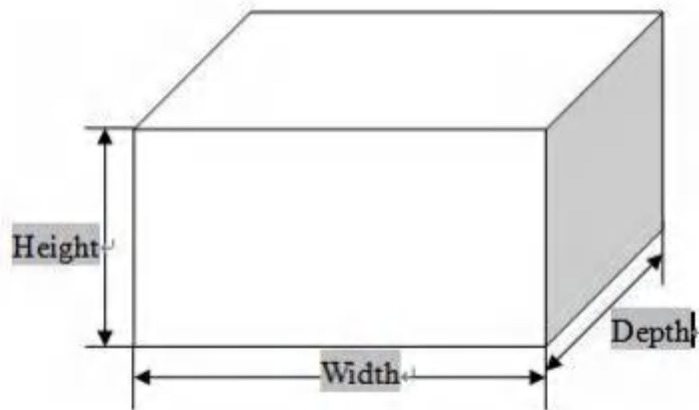

	Main unit of the analyzer
(mm) Width	≤400
(mm) Height	≤520
(mm) Depth	≤532
(Kg) Weight	≤28

B.14 Contraindications

None

Appendix C Communication

C.1 Auto Hematology Analyzer communication protocol instruction

Application Scope:

Compliant to TEK8520, 5-part Hematology Analyzer link to LIS system communication protocol

Content:

1、Form 1

<STX>	Word group transfer beginning character 0x02
Text Data	
Image Data	
<ETX>	Word group transfer terminate character 0x03

Note1: System setting->communication setting->setting connection mode of serial port, network port, and check connect to network.

Note2: serial port parameter: 115200 , n, 8 , using standard serial port intersecting line.

Note3: Net port parameter: IP: IP address of receiving terminal server, Port number: receiving terminal server port numbers (Note: Must be Match)

Form 2: The sample data format.

Abbreviation	Model 1 content	Example	Beinning character position	Character length
	beinning character	2	1	1
Textual data				
	Send sequence number	001	2	3
	Sample registration NO	000000001	5	9
	Specimen Type	N	14	1
	Specimen number	000999	15	6
	Name	Mike	21	30
	Sex	Male	51	2
	Age	17	53	6
	Age unit	year	59	6
	Sampling mode	1	61	1
	Date	YYYYMMD D	66	8
	Time	HH:MM:SS	74	8
	RBC result		82	50
	WBC result		132	50
	PLT result		182	50
	Result qty	N (Qty)	232	2
	Graph qty	5	234	1
	Subject NO result	0 6.5	235	9
	9
	Subject NO result	N= Result qty	9

C.1.1 HL7 Interface protocol supporting message

The function of LIS of IPU software on automatic Hematology Analyzer has capable of communicating with lab appliance and ethernet, which sending test results to lab appliance and receiving working instructor from that. The communicating protocol based on standard definition of HL7 which initially defined by USA as electronic data interchange criterion in the medical field and adopted by many countries. this protocol defined by HL7 v2.3. 1. please reference to *HL7 Interface Standards Version 2.3. 1*.

C.1.2 Underlying transport protocol

Graphic data				
	Graphic 1 name	RBC	1	3
	File format	BMP	4	3
	File length	8478	7	5
	Graphic 1 file content		12	File length
			
	Graphic n name	SCT	-	3
	File format	BMP	-	3
	File length	66358	-	5
	Graphic n file content		-	File length
	Terminal character	3	-	1

IPU software transport message by through connecting TCP, the process divided into 3 parts;

1. Connect

Initiate IPU software, the software connects to LIS server unceasingly and maintain stable message transportation.

2. Data transfer

In addition to sending message records by list review and quality control interface, IPU software will be able to transport counting results of newly samples simultaneously if automatic communication switch wrongly be set to closed.

No matter batch communication or automatic communication, step of messages transportation would be simultaneously. the transportation process will not be over until messages be confirmed in 10s and send next message; the system will skip to next message sending if did not receive confirmation in 10s.

The quality control data record communication the same as to counting result model, to click quality or quality result review interface to send message.

Note that there is different in two-way LIS inquiry model. When two-way switch of IPU software open, working bill record or before counting function will send inquiry message, including sample number, by which LIS check sample information and respond in HL7 message way. Than IPU fill in working bill or counting. The inquiry would be failure if did not receive response in 10s.

3. Disconnect

When IPU software exit, communication automatically shut down. To amending software setting, communication disconnected and connect again by new setting.

C.1.3 HL7 Message protocol

HL7 Uplying message protocol

Sample result data transportation in mode of UTF-8 coded string.

Message coded string organized in HL7 standard, means one message contains multsegments, each segment divided into mult-sub components.

HL7 message example as below:

```
MSH|^~\&|BC-5380|DRAWELL|||20080419104618||ORU^R01|1|P|2.3.
1|||U NICODE PID|1||7393670^^^^MR||^LIUJIA||19950804000000|女
PV1|1|outpatient|internal medical|||||||||self expence
OBR|1||20071207011|00001^Automated
Count^99MRC||20071207080000|2007120716000
0||DRAWELL||cold|20071207083000|||||HM|||||Tec
om OBX|1|IS|08001^Take Mode^99MRC||O|||||F
OBX|2|IS|08002^Blood Mode^99MRC||W|||||F
OBX|3|IS|08003^Test
Mode^99MRC||CBC+DIFF|||||F
OBX|4|IS|01002^Ref Group^99MRC||child|||||F
```

TCP/IP is a byte stream protocol, which do not offer message boundary. HL7 as upperlying protocol based on message, do not offer message terminated mode. to be sured message boundary, we use MLLP underlying protocol (*HL7 Interface Standards Version 2.3. 1*)

<SB> *dddd* <EB><CR>

among:

<SB> = Start Block character (1 byte)

ASCII <VT> , is, <0x0B> 。 do not miss ASCII SOH or STX.

***ppppp* = Data (variable number of bytes)**

dddd is HL7 valid data , use UTF-8 code.

<EB> = End Block character (1 byte)

ASCII <FS>, is<0x1C>. do not miss up ASCII ETX or EOT.

<CR> = Carriage Return (1 byte)

ASCII return , <0x0D>

C.2 HL7 Introduction

C.2.1 HL7 Basic syntax

Message construction rules

Each HL7 message consists of some (Segment) , each message terminated by <CR>

Every message consists of 3 codes and variable characters (Field) , each field consists of (Component) and (SubComponent) .to define field , component and subcomponent on each MSH.

Example:

```
MSH|^~\&|DRAWELL|BC-5380|||20060427194802||ORU^R01|1|P|2.3.
```

```
1|||||UNICODE Among:
```

Definition of 5 characters after MSH to distinguish each field , component and subcomponent.although these characters can be nontext, but recommendation as below of characters.

Character	Definition
	Character Separator
^	Component Separator
&	Subcomponent Separator
~	Repetition Separator
\	Escape Character

The first MSH field including each of separative sign, some of them empty on the backend, for it choice and DRAWELL HL7 interface did not use it, the detailed definition of field and adoption introduced afterward.

Any kind of message after MSH field, message field has fixed sequence, the following sections will describe this sequence by using syntax constructio.

[] Message inside can be optional.

{ } Message inside can be repetition one time or more times

In field data type of ST、TX、FT、CF, for example : among of notes、 diagnostic messages、 user defined sex etc, character string possibly appear escape separative sign, should change original character into escape character sequence, and decoding to return. HL7 interface escape rule as below.

Escape character sequence	Original character
\F\	Field Separator
\S\	component Separator
\T\	subcomponent Separator
\R\	Repetition Separator
\E\	Escape Separator
\.br\	<CR> , end of text

Notes: The '\ ' in string escape sequences representative escape the delimiter, The value defined in the MSH message segments.

C.2.2 HL7 Data type

All of data message defined as different HL7 type character field, only parts of standard HL7 used by communication protocol. The introduction find to appendix C4: the definition of HL7 data type

C.3 TWO-WAY communication

C.3.1 Supporting HL7 message.

Process of two-way communication

1. The main PC unit send directly inspection result(or quality control data)to LIS, as chart2.

Note: R01 Event:main unit of PC active send test result to LIS. Test result and QC data information can be sent both by this method.

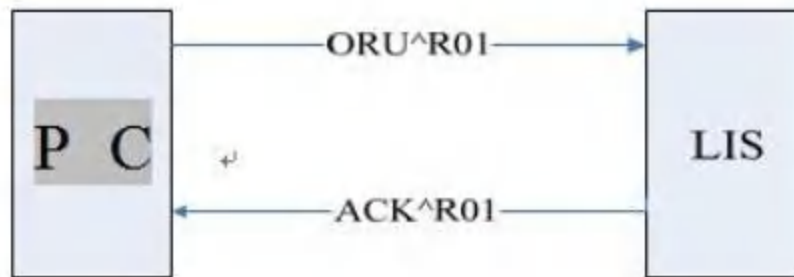

Figure 2 Schematic diagram of control data communication process The test results

2. Working order inquiry

Order message belongs to working bill, can take use of related HL7:ORM (General Order Message)、ORR (General Order Response Message), as chart 3

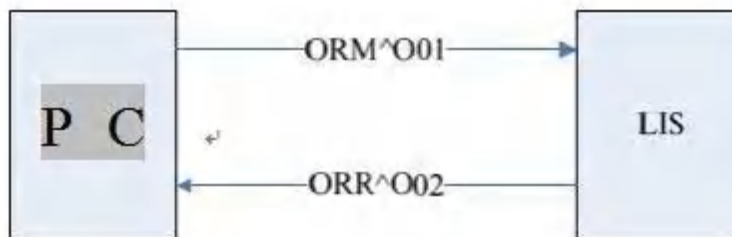

Figure 3 Work list query communication process schematic diagram

Main message used

ORU^R01 : Used to transfer of result and quality control data.

ORU Observational Results (Unsolicited)

MSH message head, necessity, including code 、 time 、 saparector and encode model etc.

```

{
  PID Patient basic information, including name 、 sex 、 record NO、
  birthday etc.
  [PV1] Patient visit information, including type、 Dept、 bed NO、 medical
  treatment etc.

  {
    OBR sample data , including sample NO 、 inspector 、 time etc.
    {[OBX]} Data , including results, work model and related
    dataetc.
  }
}

```

ACK^R01 data: Confirm receiving message ORU^R01 。

ACK Acknowledgment

MSH messag head

MSA message confirm , indicate receiving of communication.

ORM^O01 data: Order, related to Order used type of message, for example: to creat a new order、 to cancelorder etc, here Pc main unit require LIS fill in order message again。

ORM General Order Message

MSH messgae head

{ORC}Order , including sample numbers

ORR^O02 data: ORM^O01 confirm , return to order (working order) data。

ORR^O02 General Order Response Message

MSH message head

MSA confirm

[PID] Patient

[PV1]] visit

{

ORCOrder general information , including sample number/

[OBR] sample data

{[OBX]} Other sample data item, including sample working model

etc.

C.3.2 Definition of related to HL7 message field

各 Definition of character field contain of each message, which indicated as below, one line in form response to one character of message field, and definition of each line in form listed as below;

1. NO.HL7 messages begin by sign 3 as name of message field, and every content after each field separator follows, its number to be HL7 with sequence position.

example:

```

PID      | 1      | | 7393670^^^^MR||^刘佳||19950804000000|女
  ↑      ↑      ↑
Field name field1      field3
  
```

NOTE: MSH message has little difference, the field after field name taken as first field, to descrip separator value used by the whole message field.

2. Field name: field logical meaning.
3. Data type: HL7 standard type, Its composition will be indicated at HL7 data type definition of appendix.
4. Maximum suggested length: recommened by HL7 。 But in real process of transfer, reality length would beyond that value , so take separator as marking to fetch message field in analyze message.
5. Instruction: to content of real message field.
6. Example: example of real field value.

MSH (Message Header) contain HL7 basic message , including message separator value、 message type and message encode way tec , the first field of each HL7 messages。

Rxample:

```
MSH|^~\&|BC-5380|DRAWELL|||20080419104618||ORU^R01|1|P|2.3.
```

```
1|||||U NICODE MSH
```

Definition of character used in message field chart 1

chart 1 Definition

N O	Field name	Data type	Max suggest length	Instruction	example
1	Field Seperator	ST	1	Seperator Contain field 1 after field name,used to set seperator value of left field.	
2	Encoding Characters	ST	4	Contain parts seperator 、 repeat seperator 、 escape seperator 、 sub-parts seperator.	^~\&
3	Sending application	EI	180	Transmitter application。 If main server transmit, value should be —TEK-8530 or —TEK8520	TEK8530

4	Sending Facility	EI	180	Transmitter device. value—DRAWELL	DRAWELL
7	Date/Time Of Message	TS	26	Creation time (YY[MM[DD[HH[MM[SS]]]]), system time	20080419104618
9	Message Type	CM	7	Message type.	ORU^R01
10	Message Control ID	ST	20	To identify one message.	1
11	Processing ID	PT	3	Value : —P— sample , inquiry information; —Q— quality control count result; identical to forward receiving message in ACK	P
12	Version ID	VID	60	HL7 VERSION number, value—2.3.1	2.3.1
18	Character Set	ID	10	Characters file . value—UNICODE , transfer message as	UNICODE

MSA

MSA (Message Acknowledgement) Message field contain confirm information.

Example:

MSA|AA|1

Field used to see chart 2

Chart 2 MSA field define list

NO	Field name	Data type	Max suggest length	Instruction	example
1	Acknowledgment Code	ID	2	Confirm code—: AA— receive , —AE— error , —AR— reject.	AA
2	Message Control ID	ST	20	Message Control ID, ,Correspondent to MSH- 10 of receiveing message.	1
6	Error Condition	CE	100	Transmission option , or contain error information, Value reference to chart 3.	

Chart 3 characters error code list of MSA-6

Condition code (MSA-6)	Condition text (MSA-3)	description/Note
Success:		AA
0	Message accepted	Success:
Error condition code:		AE
100	Segment sequence error	Wrong in sequence of message field, or lost must be field
101	Required field missing	Lost key character in field.
102	Data type error	Error in data type.
103	Table value not found	Calue can not be find.
Reject condition		AR
200	Unsupported message type	Message type unspported
201	Unsupported event code	Event code unspported
202	Unsupported processing id	Processing ID unspported
203	Unsupported version id	versionID unspported
204	Unknown key identifier	Unindentify key mark.
205	Duplicate key identifier	Repeat key character exist.
206	Application record locked	Event in the application memory level can not perform.
207	Application internal error	Other error in application.

PID

PID (Patient Identification) Contain basic information of patient.

Example: PID|1||7393670^^^MR||^LIUJIA||19950804000000|female

Field used to see chart 4

Chart 4 characters error code list of PID

NO	Field name	Data type	Max suggest leng	Instru ction	Example
1	Set ID - PID	SI	4	S/N , Mark different PID in message.	1
3	Patient Identifier List	CX	20	In control messgae, it mark as control bacth number. In sample inspection result message, used as medical record mark — r e c o r d n o ^^^^MRl ni,	7393670^^^^MR R

5	Patient Name	XP N	48	P a t i e n t n a m e (FirstName and LastName) .	LIUYJIA
7	Date/Time of Birth	TS	26	In sample result message, Used as indicate birth time. In control messgae, it mark as control valid time.	1995080400000 0
8	Sex	IS	1	sex , character string	femal

PV1

PV1 (Patient Visit) Contain basic information of visit.

Example: PV1|1|outpatient|internal medical|||||||||||||||self expense

Field used to see chart 5

Chart 5 characters error code list of PV1

NO.	Field name	Data type	Max suggest length	Instruction	Example
1	Set ID - PV1	SI	4	S/N , Mark different PID in message. PV1 message field	1
2	Patient Class	IS	1	Patient type , character string, unlimited content	outpatient
3	Assigned Patient Location	PL	80	Patient postion , —Dept^ ^bed number	Internal medical
20	Financial Class	FC	50	Duty type , character string, unlimited content	Self expense

OBR

OBR (Observation Request) Mainly contain exam report.

Example:

OBR|1||20071207011|00001^Automated

Count^99MRC||20071207080000|2007120716000

0||DRAWELL||cold|20071207083000|||||||HM|||||||DRAWELL

Field used to see chart 6.

Chart 6 characters error code list of OBR

NO	Field name	Data type	Max suggest length	Instruction	Example
1	Set ID - OBR	SI	10	S/N , Mark different OBR in message.	1
2	Placer Order Number	EI	22	In cheking response working order, ORC^O02 used as sample number.	
3	Filler Order Number +	EI	22	In message of inspect result, as sample number and to be file number in control message.	20071207011
4	Universal Service ID	CE	200	General service mark, used to maring different count result type. Value referene to see message code define in appendix C5.	00001^Auto mate d Count^99MR C
6	Requested Date/time	TS	26	Apply time 。 Sampling time	200712070800 00
7	Observation Date/Time #	TS	26	Inspect time	200712071600 00
10	Collector Identifier *	XC N	60	sampler	DRAWELL
13	Relevant Clinical Info.	ST	300	Related clinic information。 Patient clinic dignosis information.	感冒
14	Specimen Received Date/Time *	TS	26	Sample receive time	200712070830 00

15	Specimen Source *	CM	300	Sample source. HL7 value as: —BLDV— venous blood —BLDC— peripheral blood	
22	Results Rpt/ Status Chng - Date/ Time +	TS	26	Result report/condition change-time	
24	Diagnostic Serv Sect	ID	10	Dianositic part ID , value as—HM—, means Hematology	HM

28	Result Copies To	XC N	60	Result copy	
32	Principal Result Interpreter +	CM	200	Result constructionst in sample information and to be operater in control count massage	DRAWELL

OBX

OBX (Observation/Result) Mainly contain each result parameter information.

Example:

OBX|6|NM|6690-2^WBC^LN||4.63|10*9/L|11.00- 12.00|L||F||E

Field used to see chart 7.

Chart 7 characters error code list of OBX

NO	Field name	Data type	Max suggest length	Instruction	Example
1	Set ID - OBX	SI	10	S/N , Mark different OBX in message.	6
2	Value Type	ID	3	File of Result type,value as —ST—、—NM—、—ED—、—IS—etc	NM

3	Observation Identifier	CE	590	<p>Soecial case mark。</p> <p>—ID^Name^EncodeSys , ID: exam item mark , Name :item describ information , EncodeSys: tien encode system. Each exam item code reference to appendix C5.</p> <p>MOTE: ID and EncodeSys : be used as only one besured examparameter. Name: main description not a mark.</p>	6690-2^W BC^LN
5	Observation Value	*	65535	<p>Result data , can be number 、 character string 、 enumeration values、 binary data etc, reference to appendix C.5。</p> <p>(binary data like histogram and scatter diagram taken transformed adopting Base64 encode way, reference to appendix C.6。</p>	4.63
6	Units	CE	90	<p>Item unit adopt 。 ISO standard。 Transfer unit contained in appendix C.5 。</p>	10*9/L
7	Reference s Range	ST	90	<p>Result range : —reference range lower limit- reference range upper limit .</p>	11.00- 12.00
8	Abnormal Flags	ID	5	<p>Result mark , type as;</p> <p>—N - normal</p> <p>—A - abnormal</p> <p>—H - result upper reference range upper limit </p> <p>—L -result lower reference range lower limit </p> <p>NOTE: this Field possiblly show unusual mark or high and low alarmstimultaneously, many mark connected by —~ , for example—H~A many marks connected by</p>	L
11	Observ Result Status	ID	1	<p>Result condition 。 Value as—F - (Final Result) ,</p>	F

13	User Defined Access Checks	ST	20	User defined content , To store reagent expired mark and amend mark. Three types mark: O –reagent expired E –initiative edit e –passive edit	E
----	----------------------------	----	----	--	---

ORC

ORC (Common Order) Mainly contain general information as order.

Example:

ORC|RF||SampleID||IP

Field used to see chart 8.

Chart 8 characters error code list of ORC

NO	Field name	Data type	Max suggest length	Instruction	Example
1	Order Control	ID	2	Order control character。 Value: ORM by—RF , means—refill order inquiry ORR by—AF , means—order reconfirm	RF
2	Placer Order Number	EI	22	Order : Initiater number. In ORM , value as empty, in ORR, value as samle number	
3	Filler OrderNum	EI	22	Order: Receiver number. In ORM , value as sample number. In ORR , Value as empty.	SampleID
5	Order Status	ID	2	Order: condition。 In working order inquiry transfer of OEM message; fixed value as —IP , means — order processing, no result. ; value in ORR as empty.	IP

C.3.3 Complete message demonstration

Two messages demonstrate process of sample data communication as below;

```
MSH|^~\&|BC-5380|DRAWELL|||20080419104618||ORU^R01|1|P|2.3.
1|||||UNICODE PID|1||7393670^^^MR|^ LIUJIA ||19950804000000| female
PV1|1| outpatient|internal medical |||||||||| expenseOBR|1||20071207011|00001^Automated
Count^99MRC||20071207080000|20071207160000||DRAWELL|| cold
|20071207083000|||||HM|||||DRAWELL
OBX|1|IS|08001^Take Mode^99MRC||O||||F
OBX|2|IS|08002^Blood Mode^99MRC||W||||F
OBX|3|IS|08003^Test
Mode^99MRC||CBC+DIFF||||F
OBX|4|IS|01002^Ref Group^99MRC|| child ||||F

OBX|5|NM|30525-0^Age^LN||13|yr||||F

OBX|6|NM|6690-2^WBC^LN||4.63|10*9/L|11.00- 12.00|L||F||
E
OBX|7|NM|704-7^BAS#^LN||***.***|10*9/L|0.00-0.10|||F||e

OBX|8|NM|706-2^BAS%^LN||**.***|0.0- 1.0|||F
OBX|9|NM|751-8^NEU#^LN||***.***|10*9/L|2.00-7.00|||F||e
OBX|10|NM|770-8^NEU%^LN||**.***|50.0-70.0|||F
OBX|11|NM|711-2^EOS#^LN||***.***|10*9/L|0.02-0.50|||F||e
OBX|12|NM|713-8^EOS%^LN||**.***|0.5-5.0|||F
OBX|13|NM|731-0^LYM#^LN||***.***|10*9/L|0.80-4.00|||F||e
OBX|14|NM|736-9^LYM%^LN||**.***|20.0-40.0|||F
OBX|15|NM|742-7^MON#^LN||***.***|10*9/L|0. 12-0.80|||F||e
OBX|16|NM|5905-5^MON%^LN||**.***|3.0-8.0|||F
OBX|17|NM|26477-0^*ALY#^LN||***.***|10*9/L|0.00-0.20|||F||e
OBX|18|NM|13046-8^*ALY%^LN||**.***|0.0-2.0|||F
OBX|19|NM|10000^*LIC#^99MRC||***.***|10*9/L|0.00-0.20|||F||e
OBX|20|NM|10001^*LIC%^99MRC||**.***|0.0-2.5|||F
OBX|21|NM|789-8^RBC^LN||2.34|10*12/L|4.00-5.20|L||F
OBX|22|NM|718-7^HGB^LN||72|g/L|120-160|L||F
OBX|23|NM|787-2^MCV^LN||96. 1|fL|80.0- 100.0|N||F
OBX|24|NM|785-6^MCH^LN||30.8|pg|27.0-31.0|N||F
OBX|25|NM|786-4^MCHC^LN||321|g/L|320-360|N||F
OBX|26|NM|788-0^RDW-CV^LN||14.5|%|11.5- 14.5|N||F
OBX|27|NM|21000-5^RDW-SD^LN||59.3|fL|35.0-56.0|H||F
OBX|28|NM|4544-3^HCT^LN||22.5|%|35.0-49.0|L||F
OBX|29|NM|777-3^PLT^LN||133|10*9/L|100-300|N||F
OBX|30|NM|32623- 1^MPV^LN||9.8|fL|7.0- 11.0|N||F
OBX|31|NM|32207-3^PDW^LN||16.3||15.0- 17.0|N||F
OBX|32|NM|10002^PCT^99MRC||0.130|%|0.108-0.282|N||F
OBX|33|IS|12000^WBC Abnormal scattergram^99MRC||T||||F
OBX|34|IS|12014^Anemia^99MRC||T||||F
```

OBX|35|NM|15001^WBC Histogram. Left Line^99MRC||13||||F
OBX|36|NM|15002^WBC Histogram. Right Line^99MRC||68||||F
OBX|37|NM|15003^WBC Histogram. Middle Line^99MRC||33||||F
OBX|38|ED|15008^WBC Histogram. BMP^99MRC||^Image^BMP^Base64^.....WBC
Histogram data ||||F

OBX|39|NM|15051^RBC Histogram. Left Line^99MRC||30||||F
OBX|40|NM|15052^RBC Histogram. Right Line^99MRC||165||||F
OBX|41|ED|15056^RBC Histogram. BMP^99MRC||^Image^BMP^Base64^... ..RBC Histogram
data ||||F

OBX|42|NM|15111^PLT Histogram. Left Line^99MRC||3||||F
OBX|43|NM|15112^PLT Histogram. Right Line^99MRC||49||||F
OBX|44|ED|15116^PLT Histogram. BMP^99MRC||^Image^BMP^Base64^PLT Histogram
data ||||F
OBX|45|ED|15200^WBC DIFF Scattergram. BMP^99MRC||^Image^BMP^Base64^.....DIFF
Scatter plot data ||||F

OBR|2||20071207011|00002^Manual Count^99MRC|||||BLDV
 OBX|46|NM|30341-2^ESR^LN||0|mm/hr|0-20|||F
 OBX|47|NM|747-6^Myeloblasts%. Manual^LN||0.0|%|||F
 OBX|48|NM|783- 1^Promyelocytes%. Manual^LN||0.0|%|||F
 OBX|49|NM|749-2^Myelocytes%. Manual^LN||0.0|%|||F
 OBX|50|NM|740- 1^Metamyelocyte%. Manual^LN||0.0|%|||F
 OBX|51|NM|764- 1^Neuts Band%. Manual^LN||0.0|%|||F
 OBX|52|NM|769-0^Neuts Seg%. Manual^LN||0.0|%|||F
 OBX|53|NM|714-6^Eosinophils%. Manual^LN||0.0|%|||F
 OBX|54|NM|707-0^Basophils%. Manual^LN||0.0|%|||F
 OBX|55|NM|33831-9^Lymphoblasts%. Manual^LN||0.0|%|||F
 OBX|56|NM|6746-2^Prolymphocytes%. Manual^LN||0.0|%|||F
 OBX|57|NM|737-7^Lymphocytes%. Manual^LN||0.0|%|||F
 OBX|58|NM|29261-5^Abnormal Lymphs%. Manual^LN||0.0|%|||F
 OBX|59|NM|33840-0^Monoblasts%. Manual^LN||0.0|%|||F
 OBX|60|NM|13599-6^Promonocytes%. Manual^LN||0.0|%|||F
 OBX|61|NM|744-3^Monocytes%. Manual^LN||0.0|%|||F
 OBX|62|NM|18309-5^NRBCs%. Manual^LN||0.0|%|||F
 OBX|63|NM|31112-6^Reticulocytes%. Manual^LN||0.0|%|||F
 OBX|64|NM|11000^Undefined Cells%. Manual^99MRC||0.0|%|||F
 OBX|65|NM|11001^Other Abnormal Cells%. Manual^99MRC||0.0|%|||F

Every received sample result by sample response message , need to response a sample message.sample response message contain twomessage field: MSH and MSA 。 The correct response require to note two points: MSH-9 ne e d fil l c o n t e n t as ACK^R01, indicate this message type belong to sample response message. MSA-2 character field value should be identical with MSH- 10 character field of received counting result, indicate response message be identical to sent count result, this sample chart value as MSA-2 ;

MSH|^~&|LIS|||20080419104633||ACK^R01|1|P|2.3. 1||||UNICODE
 MSA|AA|1

Quality control message sample;

Quality control message content model has defference from sample count result message: MSH- 11 in quality control message value as Q, means message type as quality control data; one message of quality control response to one quality control point , possibly consist of multy count results , For example;a L-J quality control message contain acount result , and a X-R quality control message may contain twocount results and average count results . Quality control message consist of a MSH message head and mult count results , each count result contain sample information of message field iniation of PID 、 OBR, Follow up by mult OBX message fields, for carry parameters and othe information.OBR-4 character field of every count result means count result type,whather is a X-R count result , average count result of X-R , or a count result of L-J , according to definition message encode in apendix.

X-R Quality control message sample as below:

MSH|^~&|BC-5380|DRAWELL|||20081120171602||ORU^R01|1|Q|2.3. 1||||UNICODE
 PID|1||6666666|||20080807235959

OBR|1||6|00006^XR QCR^99MRC||20080807142518|||||||||||||HM||||| Engineer

OBX|1|IS|05001^Qc Level^99MRC||M|||||F

OBX|2|IS|08001^Take Mode^99MRC||C|||||F

OBX|3|IS|08002^Blood Mode^99MRC||W|||||F

OBX|4|NM|6690-2^WBC^LN||0.00|10*9/L|||||F

OBX|5|NM|704-7^BAS#^LN||***.**|10*9/L|||||F

OBX|6|NM|706-2^BAS%^LN||**.*%|||||F

OBX|7|NM|751-8^NEU#^LN||***.**|10*9/L|||||F

OBX|8|NM|770-8^NEU%^LN||**.*%|||||F

OBX|9|NM|711-2^EOS#^LN||***.**|10*9/L|||||F

OBX|10|NM|713-8^EOS%^LN||**.*%|||||F

OBX|11|NM|731-0^LYM#^LN||***.**|10*9/L|||||F

OBX|12|NM|736-9^LYM%^LN||**.*%|||||F

OBX|13|NM|742-7^MON#^LN||***.**|10*9/L|||||F

OBX|14|NM|5905-5^MON%^LN||**.*%|||||F

OBX|15|NM|789-8^RBC^LN||0.02|10*12/L|||||F

OBX|16|NM|718-7^HGB^LN||0|g/L|||||F

OBX|17|NM|787-2^MCV^LN||***.*|fL|||||F

OBX|18|NM|785-6^MCH^LN||***.*|pg|||||F

OBX|19|NM|786-4^MCHC^LN||***.*|g/L|||||F

OBX|20|NM|788-0^RDW-CV^LN||**.*%|||||F

OBX|21|NM|21000-5^RDW-SD^LN||***.*|fL|||||F

OBX|22|NM|4544-3^HCT^LN||0.0|%|||||F

OBX|23|NM|777-3^PLT^LN||4|10*9/L|||||F

OBX|24|NM|32623- 1^MPV^LN||**.*|fL|||||F

OBX|25|NM|32207-3^PDW^LN||**.*|||||F

OBX|26|NM|10002^PCT^99MRC||.**.*%|||||F

OBX|27|NM|10003^GRAN-X^99MRC||6|||||F

OBX|28|NM|10004^GRAN-Y^99MRC||32|||||F

OBX|29|NM|10005^GRAN-Y(W)^99MRC||20|||||F

OBX|30|NM|10006^WBC-MCV^99MRC||83|||||F

OBX|31|NM|15001^WBC Histogram. Left Line^99MRC||10|||||F

OBX|32|NM|15002^WBC Histogram. Right Line^99MRC||72|||||F

OBX|33|NM|15003^WBC Histogram. Middle Line^99MRC||37|||||F

OBX|34|ED|15008^WBC Histogram. BMP^99MRC||^Image^BMP^Base64^.....WBC Histogram data |||||F

OBX|35|NM|15051^RBC Histogram. Left Line^99MRC||10|||||F

OBX|36|NM|15052^RBC Histogram. Right Line^99MRC||250|||||F

OBX|37|ED|15056^RBC Histogram. BMP^99MRC||^Image^BMP^Base64^... ..RBC Histogram data |||||F

OBX|38|NM|15111^PLT Histogram. Left Line^99MRC||3|||||F

OBX|39|NM|15112^PLT Histogram. Right Line^99MRC||24|||||F

OBX|40|ED|15116^PLT Histogram. BMP^99MRC||^Image^BMP^Base64^PLT Histogram data |||||F

OBX|41|ED|15200^WBC DIFF Scattergram. BMP^99MRC||^Image^BMP^Base64^.....DIFF Scatter plot data |||||F

PID|2||6666666||20080807235959

OBR|2||6|00006^XR QCR^99MRC||20080807142640|||||||||||||HM||||| engineer

OBX|42|IS|05001^Qc Level^99MRC||M|||||F
OBX|43|IS|08001^Take Mode^99MRC||C|||||F
OBX|44|IS|08002^Blood Mode^99MRC||W|||||F
OBX|45|NM|6690-2^WBC^LN||0.00|10*9/L|||||F
OBX|46|NM|704-7^BAS#^LN||***.***|10*9/L|||||F
OBX|47|NM|706-2^BAS%^LN||**.*|%|||||F
OBX|48|NM|751-8^NEU#^LN||***.***|10*9/L|||||F
OBX|49|NM|770-8^NEU%^LN||**.*|%|||||F
OBX|50|NM|711-2^EOS#^LN||***.***|10*9/L|||||F
OBX|51|NM|713-8^EOS%^LN||**.*|%|||||F
OBX|52|NM|731-0^LYM#^LN||***.***|10*9/L|||||F
OBX|53|NM|736-9^LYM%^LN||**.*|%|||||F
OBX|54|NM|742-7^MON#^LN||***.***|10*9/L|||||F
OBX|55|NM|5905-5^MON%^LN||**.*|%|||||F
OBX|56|NM|789-8^RBC^LN||0.02|10*12/L|||||F
OBX|57|NM|718-7^HGB^LN||0|g/L|||||F
OBX|58|NM|787-2^MCV^LN||***.*|fL|||||F
OBX|59|NM|785-6^MCH^LN||***.*|pg|||||F
OBX|60|NM|786-4^MCHC^LN||***.*|g/L|||||F
OBX|61|NM|788-0^RDW-CV^LN||**.*|%|||||F
OBX|62|NM|21000-5^RDW-SD^LN||***.*|fL|||||F
OBX|63|NM|4544-3^HCT^LN||0.0|%|||||F
OBX|64|NM|777-3^PLT^LN||5|10*9/L|||||F
OBX|65|NM|32623- 1^MPV^LN||**.*|fL|||||F
OBX|66|NM|32207-3^PDW^LN||**.*|%|||||F
OBX|67|NM|10002^PCT^99MRC||.***|%|||||F
OBX|68|NM|10003^GRAN-X^99MRC||28|||||F
OBX|69|NM|10004^GRAN-Y^99MRC||19|||||F
OBX|70|NM|10005^GRAN-Y(W)^99MRC||20|||||F
OBX|71|NM|10006^WBC-MCV^99MRC||60|||||F
OBX|72|NM|15001^WBC Histogram. Left Line^99MRC||10|||||F
OBX|73|NM|15002^WBC Histogram. Right Line^99MRC||72|||||F
OBX|74|NM|15003^WBC Histogram. Middle Line^99MRC||37|||||F
OBX|75|ED|15008^WBC Histogram. BMP^99MRC||^Image^BMP^Base64^.....WBC Histogram data |||||F
OBX|76|NM|15051^RBC Histogram. Left Line^99MRC||10|||||F
OBX|77|NM|15052^RBC Histogram. Right Line^99MRC||250|||||F
OBX|78|ED|15056^RBC Histogram. BMP^99MRC||^Image^BMP^Base64^RBC Histogram data |||||F
OBX|79|NM|15111^PLT Histogram. Left Line^99MRC||3|||||F
OBX|80|NM|15112^PLT Histogram. Right Line^99MRC||24|||||F
OBX|81|ED|15116^PLT Histogram. BMP^99MRC||^Image^BMP^Base64^PLT Histogram data |||||F
OBX|82|ED|15200^WBC DIFF Scattergram. BMP^99MRC||^Image^BMP^Base64^DIFF Scatter plot data |||||F PID|3||6666666
OBR|3||6|00008^XR QCR Mean^99MRC|||||||||||||HM
OBX|83|NM|6690-2^WBC^LN||0.00|10*9/L|||||F
OBX|84|NM|704-7^BAS#^LN||***.***|10*9/L|||||F
OBX|85|NM|706-2^BAS%^LN||**.*|%|||||F

OBX|86|NM|751-8^NEU#^LN||***.**|10*9/L||||F
 OBX|87|NM|770-8^NEU%^LN||**.*|%||||F
 OBX|88|NM|711-2^EOS#^LN||***.**|10*9/L||||F
 OBX|89|NM|713-8^EOS%^LN||**.*|%||||F
 OBX|90|NM|731-0^LYM#^LN||***.**|10*9/L||||F
 OBX|91|NM|736-9^LYM%^LN||**.*|%||||F
 OBX|92|NM|742-7^MON#^LN||***.**|10*9/L||||F
 OBX|93|NM|5905-5^MON%^LN||**.*|%||||F
 OBX|94|NM|789-8^RBC^LN||0.02|10*12/L||||F
 OBX|95|NM|718-7^HGB^LN||0|g/L||||F
 OBX|96|NM|787-2^MCV^LN||***.*|fL||||F
 OBX|97|NM|785-6^MCH^LN||***.*|pg||||F
 OBX|98|NM|786-4^MCHC^LN||***.*|g/L||||F
 OBX|99|NM|788-0^RDW-CV^LN||**.*|%||||F
 OBX|100|NM|21000-5^RDW-SD^LN||***.*|fL||||F
 OBX|101|NM|4544-3^HCT^LN||0.0|%||||F
 OBX|102|NM|777-3^PLT^LN||5|10*9/L||||F
 OBX|103|NM|32623- 1^MPV^LN||**.*|fL||||F
 OBX|104|NM|32207-3^PDW^LN||**.*||||F
 OBX|105|NM|10002^PCT^99MRC||***.*%||||F
 OBX|106|NM|10003^GRAN-X^99MRC||17||||F
 OBX|107|NM|10004^GRAN-Y^99MRC||26||||F
 OBX|108|NM|10005^GRAN-Y(W)^99MRC||20||||F
 OBX|109|NM|10006^WBC-MCV^99MRC||72||||F

Quality control response example;

One little difference between quality control response and counting result response:MSH- 11 character field value as Q. below as a X-R quality control message ACK.

MSH|^~\&|LIS||||20081120171602||ACK^R01|1|Q|2.3. 1||||UNICODE
MSA|AA|1

Two-way LIS inquiry sample;

Two-way LIS inquiry including sample number, after LIS received, response to related patient and sample data 。 Inquiry including two message field: MSH and ORC。 MSH message field basically the same as sample counting result message field, only MSH-9 message type value as ORM^O01。 ORC-3 fill with receiver number, Here fill in sample number , This character filed as SampleID1 , NOTE , when automatic sampling count initiate inquiry , or when build in barcode scanning error, sample encode valueshows Invalid 。 Example as below;

MSH|^~\&|BC-5380|DRAWELL||||20081120174836||ORM^O01|4|P|2.3.
1||||UNICODE ORC|RF||SampleID1||IP

Two-way LIS check inquiry response example;

LIS receive inquiry message, need to reply a result response message。 Two of check

inquiry message field divide into MSH and MSA。MSH-9 fill in message

characterORR^O02。MSA message field character response sample see chart of part. if check inquiry success , Backward contain message filedPID 、 PV1 、 ORC 、 OBR、 OBX , descrippatient and model of sample description of data is the same as sample

data communication. ORC in success inquiry can not lack of , AF, ORC-2 in ORC— 1 dat avalue as character inquiry main key.sample number。 Note take OBR-2 character as sample code message, value must be equal to ORC-2 , otherwise wil be taken as error。

Below as a success result inquiry :

```
MSH|^~\&|LIS|||20081120174836||ORR^O02|1|P|2.3. 1||||UNIC
ODE MSA|AA|4
PID|1||ChartNo^^^^MR|^FName||19810506|NT PV1|1|
outpatient|internal ^^Bn4|||||||||||||NewCharge
ORC|AF|SampleID1||
OBR|1|SampleID1|||20060506|||tester||Diagnose content....|20060504|||||20080821||HM|||
checker||| Inspector

OBX|1|IS|08001^Take Mode^99MRC||A||||F
OBX|2|IS|08002^Blood Mode^99MRC||W||||F
OBX|3|IS|08003^Test Mode^99MRC||CBC||||F
OBX|4|IS|01002^Ref Group^99MRC||XXXX||||F
OBX|5|NM|30525-0^Age^LN||1|hr||||F
OBX|6|ST|01001^Remark^99MRC||remark content....||||F
```

Below a sample of failure chart, MSA-2 character indicate respond result, value as AR, indicate refuse inquiry . or be value as AE, indicate error of inquiry:

```
MSH|^~\&|LIS|||20081120175238||ORR^O02|1|P|2.3. 1||||UNICODE
MSA|AR|9
```

C.4 Appendix: Definition by HL7 Data Type

CE - Code Element

<identifier (ST)> ^ <text (ST)> ^ <name of coding system (ST)> ^ <alternate identifier (ST)> ^ <alternate text (ST)> ^ <name of alternate coding system (ST)>

CM - Composite

Format is defined by specific field.

CX - Extended composite ID with check digit

<ID (ST)> ^ <check digit (ST)> ^ <code identifying the check digit scheme employed (ID)> ^ <assigning authority (HD)> ^ <identifier type code (IS)> ^ <assigning facility (HD)>

ED – Encapsulate Data

<source application (HD) > ^ <type of data (ID) > ^ <data sub type (ID) > ^ <encoding (ID) > ^ <data (ST) >

EI - Entity Identifier

<entity identifier (ST)> ^ <namespace ID (IS)> ^ <universal ID (ST)> ^ <universal ID type (ID)>

FC – Financial Class

<financial class (IS) > ^ <effective date (TS) >

HD - Hierarchic designator

<namespace ID (IS)> ^ <universal ID (ST)> ^ <universal ID type (ID)>

Used only as part of EI and other data types.

FT - Formatted text

This data type is derived from the string data type by allowing the addition of embedded formatting instructions. These instructions are limited to those that are intrinsic and independent of the circumstances under which the field is being used.

IS - Coded value for user-defined tables

The value of such a field follows the formatting rules for an ST field except that it is drawn from a site-defined (or user-defined) table of legal values. There shall be an HL7 table number associated with IS data types.

ID - Coded values for HL7 tables

The value of such a field follows the formatting rules for an ST field except that it is drawn from a table of legal values. There shall be an HL7 table number associated with ID data types.

NM -

Numeric

A number represented as a series of ASCII numeric characters consisting of an optional leading sign (+ or -), the digits and an optional decimal point.

PL - Person

location

<point of care (IS)> ^ <room (IS)> ^ <bed (IS)> ^ <facility (HD)> ^ <location status (IS)> ^ <person location type (IS)> ^ <building (IS)> ^ <floor (IS)> ^ <location description (ST)>

PT - Processing

type

<processing ID (ID)> ^ <processing mode (ID)>

SI - Sequence

ID

A non-negative integer in the form of an NM field. The uses of this data type are defined in the chapters defining the segments and messages in which it appears.

ST -

String

TS - Time

stamp

YYYY[MM[DD[HHMM[SS[.S[S[S[S]]]]]]][+/-ZZZZ] ^ <degree of precision>

XCN - Extended composite ID number and

name

In Version 2.3, use instead of the CN data type. <ID number (ST)> ^ <family name (ST)> & <last_name_prefix (ST) ^ <given name (ST)> ^ <middle initial or name (ST)> ^ <suffix (e.g., JR or III) (ST)> ^ <prefix (e.g., DR) (ST)> ^ <degree (e.g., MD) (ST)> ^ <source table (IS)> ^ <assigning authority (HD)> ^ <name type code (ID)> ^ <identifier check digit (ST)> ^ <code identifying the check digit scheme employed (ID)> ^ <identifier type code (IS)> ^ <assigning facility (HD)> ^ <name representation code (ID)>

XPN - Extended person

name

In Version 2.3, replaces the PN data type. <family name (ST)> ^ <given name (ST)> &
<last_name_prefix (ST)> ^ <middle initial or name (ST)> ^ <suffix (e.g., JR or III) (ST)> ^
<prefix (e.g., DR) (ST)> ^ <degree (e.g., MD) (IS)> ^ <name type code (ID) > ^ <name
representation code (ID)>

VID - Version
identifier

<version ID (ID)> ^ <internationalization code (CE)> ^ <international version ID (CE)>

C.5 Appendix: Message Encoding Definition

1. In HL7 communication message, field OBR-4 (Universal Serview ID) is used for label as type of testing result. For example, sample testing result, microscope test result and control result is showed as —ID^Name^EncodeSysl. The table 9 lists all code value in this field.

Table 9 OBR-4Coding

Data	(ID)	(Name)	(EncodeSys)
Counting Result	00001	Automated Count	99MRC
Microscope test result	00002	Manual Count	99MRC
Control counting result	00003	LJ QCR	99MRC
Control counting result	00004	X QCR	99MRC
Control counting result	00005	XB QCR	99MRC
Control counting result	00006	XR QCR	99MRC
XControl counting result Mean	00007	X QCR Mean	99MRC
XRControl counting result Mean	00008	XR QCR Mean	99MRC

2. Each OBX message section contains test parameter or other data information; it's composed of fields as below:

OBX-2 identify the HL7 type of Data item

OBX-3 (Observation Identifier) is the ID of data item, shows as —ID^Name^EncodeSysl;

OBX-5 contains value of data item;

OBX-6 contains data item unit, use ISO standard.

Table 10 list all communication data item's HL7 type and ID. Table 11 list all communication data unit.

Table 10 Data Item Type and Code System

Data Item	HL7 Type (OBX-2)	Code (ID)	Name (Name)	Coding System (EncodeSys)	OBX-3 Field sample
Other Data Item					
Take Mode	IS	08001	Take Mode	99MRC	08001^Take Mode^99MRC
Blood Mode	IS	08002	Blood Mode	99MRC	08002^Blood Mode^99MRC
Test Mode	IS	08003	Test Mode	99MRC	08003^Test Mode^99MRC
Age	NM	30525-0	Age	LN	30525-0^Age^LN
Remark	ST	01001	Remark	99MRC	01001^Remark^99MRC
Ref Group	IS	01002	Ref Group	99MRC	01002^Ref Group^99MRC

QC Level	IS	05001	Qc Level	99MRC	05001^Qc Level^99MRC
Test Result Data Item					
WBC	NM	6690-2	WBC	LN	6690-2^WBC^LN
BAS	NM	704-7	BAS#	LN	704-7^BAS#^LN
BAS_PER	NM	706-2	BAS%	LN	706-2^BAS%^LN
NEU	NM	751-8	NEU#	LN	751-8^NEU#^LN
NEU_PER	NM	770-8	NEU%	LN	770-8^NEU%^LN
EOS	NM	711-2	EOS#	LN	711-2^EOS#^LN
EOS_PER	NM	713-8	EOS%	LN	713-8^EOS%^LN
LYM	NM	731-0	LYM#	LN	731-0^LYM#^LN
LYM_PER	NM	736-9	LYM%	LN	736-9^LYM%^LN
MON	NM	742-7	MON#	LN	742-7^MON#^LN
MON_PER	NM	5905-5	MON%	LN	5905-5^MON%^L
ALY	NM	26477-0	*ALY#	LN	26477-0^*ALY#^L N
ALY_PER	NM	13046-8	*ALY%	LN	13046-8^*ALY%^ L
LIC	NM	10000	*LIC#	99MRC	10000^*LIC#^99M RC
LIC_P ER	NM	10001	*LIC%	99MRC	10001^*LIC%^99 M RC
RBC	NM	789-8	RBC	LN	789-8^RBC^LN
HGB	NM	718-7	HGB	LN	718-7^HGB^LN
MCV	NM	787-2	MCV	LN	787-2^MCV^LN
MCH	NM	785-6	MCH	LN	785-6^MCH^LN
MCHC	NM	786-4	MCHC	LN	786-4^MCHC^LN
RDW_CV	NM	788-0	RDW-CV	LN	788-0^RDW-CV^L
RDW_SD	NM	21000-5	RDW-SD	LN	21000-5^RDW-SD ^
HCT	NM	4544-3	HCT	LN	4544-3^HCT^LN
PLT	NM	777-3	PLT	LN	777-3^PLT^LN
MPV	NM	32623-1	MPV	LN	32623-1^MPV^LN
PDW	NM	32207-3	PDW	LN	32207-3^PDW^LN
PCT	NM	10002	PCT	99MRC	10002^PCT^99MR C
GRAN-X	NM	10003	GRAN-X	99MRC	10003^GRAN-X^9 9
GRAN-Y	NM	10004	GRAN-Y	99MRC	10004^GRAN-Y^9 9

GRAN-Y(W)	NM	10005	GRAN-Y(W)	99MRC	10005^GRAN-Y(W)
WBCMCV	NM	10006	WBC-MCV	99MRC	10006^WBC-MCV^9
Microscope Test Result and relative data					
Blood Type	ST	882-1	Blood Type	LN	882-1^Blood Type^LN
WBC Morphology	ST	11156-7	WBC Morphology	LN	11156-7^WBC Morphology^LN
RBC Morphology	ST	6742-1	RBC Morphology	LN	6742-1^RBC Morphology^LN
PLT Morphology	ST	11125-2	PLT Morphology	LN	11125-2^PLT Morphology^LN
Myeloblast	NM	747-6	Myeloblasts%. Manual	LN	747-6^Myeloblasts%. Manual^LN
Promyelocyte	NM	783-1	Promyelocytes%. Manual	LN	783-1^Promyelocytes%. Manual^LN
Myelocyte	NM	749-2	Myelocytes%. Manual	LN	749-2^Myelocytes%. Manual^LN
MetaMyelocyte	NM	740-1	Metamyelocyte%. Manual	LN	740-1^Metamyelocyte%. Manual^LN
BandForm Neut	NM	764-1	Neuts Band%. Manual	LN	764-1^Neuts Band%. Manual^LN
SegmentNeut	NM	769-0	Neuts Seg%. Manual	LN	769-0^Neuts Seg%. Manual^LN
Eosinophils	NM	714-6	Eosinophils%. Manual	LN	714-6^Eosinophils%. Manual^LN
Basophils	NM	707-0	Basophils%. Manual	LN	707-0^Basophils%. Manual^LN
Lymphobl	NM	33831-9	Lymphoblast	LN	33831-9^Lymphob

ast			s%. Manual		lasts%. Manual^LN
Prolymphocytes	NM	6746-2	Prolymphocytes%. Manual	LN	6746-2^Prolymphocytes%. Manual^LN
Lymphocytes	NM	737-7	Lymphocytes%. Manual	LN	737-7^Lymphocytes%. Manual^LN
AbnLymph	NM	29261-5	Abnormal Lymphs%. . Manual	LN	29261-5^Abnormal Lymphs%. Manual^LN
Monoblast	NM	33840-0	Monoblasts%. . Manual	LN	33840-0^Monoblasts%. Manual^LN
Promonocytes	NM	13599-6	Promonocytes%. Manual	LN	13599-6^Promonocytes%. Manual^LN
Monocyte	NM	744-3	Monocytes%. Manual	LN	744-3^Monocytes%. Manual^LN
NRBCS	NM	18309-5	NRBCs%. Manual	LN	18309-5^NRBCs%. Manual^LN
Reticulocyte	NM	31112-6	Manual Reticulocytes%. Manual	LN	31112-6^Reticulocytes%. Manual^LN
UndefinedCells	NM	11000	Undefined Cells%. Manual	99MRC	11000^Undefined Cells%. Manual^99MRC
OtherAbnormalCells	NM	11001	Other Abnormal Cells%. Manual	99MRC	11001^Other Abnormal Cells%. Manual^99MRC
ESR	NM	30341-2	ESR	LN	
Test Result Data (WBC,RBC,PLT histogram)					
WBC Histogram . Binary	ED	15000	WBC Histogram. Binary	99MRC	15000^WBC Histogram Binaray^99MRC

WBC Histogram. Left Line	NM	15001	WBC Histogram. Left Line	99MRC	15001^WBC Histogram. Left Line^99MRC
WBC Histogram. Right Line	NM	15002	WBC Histogram. Right Line	99MRC	15002^WBC Histogram. Right Line^ 9 9 MR C
WBC Histogram. Middle Line	NM	15003	WBC Histogram. Middle Line	99MRC	15003^WBC Histogram. Middle Line^ 9 9 MR
WBC Histogram. Meta Length	NM	15004	WBC Histogram. Meta Length	99MRC	15004^WBC Histogram. Meta Length^99MRC
WBC Histogram. Left Line Adjusted	IS	15005	WBC Histogram. Left Line Adjusted	99MRC	15005^WBC Histogram. Left Line Adjusted^99MRC
WBC Histogram. Right Line Adjusted	IS	15006	WBC Histogram. Right Line Adjusted	99MRC	15006^WBC Histogram. Right Line Adjusted^ 9 9 MR C
WBC Histogram. Middle Line Adjusted	IS	15007	WBC Histogram. Middle Line Adjusted	99MRC	15007^WBC Histogram. Middle Line Adjusted^99MR C
WBC Histogram. BMP	ED	15008	WBC Histogram. BMP	99MRC	15008^WBC Histogram. BMP^99MRC
RBC Histogram. Binary	ED	15050	RBC Histogram. Binary	99MRC	15050^RBC Histogram. Binary^99MR
RBC Histogram. Left Line	NM	15051	RBC Histogram. Left Line	99MRC	15051^RBC Histogram. Left Line^99MRC
RBC Histogram. Right Line	NM	15052	RBC Histogram. Right Line	99MRC	15052^RBC Histogram. Right Line^ 9 9 MR C

RBC Histogram. Binary Meta Length	NM	15053	RBC Histogram. Binary Meta Length	99MRC	15053^RBC Histogram. Binary Meta Length^99MRC
RBC Histogram	IS	15054	RBC	99MRC	15054^RBC

Histogram. Left Line Adjusted			Histogram. Left Line Adjusted		Histogram. Left Line Adjusted^99MRC
RBC Histogram. Right Line	IS	15055	RB C Histogram. Right Line Adjusted	99MRC	15055^RBC Histogram. Right Line Adjusted^ 9 9 MR C
RBC Histogram. BMP	ED	15056	RBC Histogram. BMP	99MRC	15056^RBC Histogram. BMP^99MR
PLT Histogram. Binary	ED	15100	PLT Histogram. Binary	99MRC	15100^PLT Histogram. Binary^99MR C
PLT Histogram. Left Line	NM	15111	PLT Histogram. Left Line	99MRC	15111^PLT Histogram. Left Line^99MRC
PLT Histogram. Right Line	NM	15112	PLT Histogram. Right Line	99MRC	15112^PLT Histogram. Right Line^ 9 9 MR C
PLT Histogram. Binary Meta	NM	15113	PLT Histogram. Binary Meta Length	99MRC	15113^PLT Histogram. Binary Meta Length^99MR C
PLT Histogram. Left Line Adjusted	IS	15114	PLT Histogram. Left Line Adjusted	99MRC	15114^PLT Histogram. Left Line Adjusted^99MRC
PLT Histogram. Right Line	IS	15115	PL T Histogram. Right Line	99MRC	15115^PLT Histogram. Right Line Adjusted^ 9 9 MR C
PLT Histogram. BMP	ED	15116	PLT Histogram. BMP	99MRC	15116^PLT Histogram. BMP^99MR
WBC DIFF Scattergram . BMP	ED	15200	WBC DIFF Scattergram . BMP	99MRC	15200^WBC DIFF Scattergram. BMP^99MRC
Abnormal Alert Information					

WBC Abnormal scattergram	IS	12000	WBC Abnormal scattergram	99MRC	12000^WBC Abnormal scattergram^99M RC
WBC Abnormal histogram	IS	12001	WBC	99MRC	12001^WBC

			Abnormal histogram		Abnormal histogram^99MRC
Leucocytosis	IS	12002	Leucocytosis	99MRC	12002^Leucocytosis^99MRC
Leucopenia	IS	12003	Leucopenia	99MRC	12003^Leucopenia^99MRC
Neutrophilia	IS	12004	Neutrophilia	99MRC	12004^Neutrophilia^99MRC
Neutropenia	IS	12005	Neutropenia	99MRC	12005^Neutropenia^99MRC
Lymphocytosis	IS	12006	Lymphocytosis	99MRC	12006^Lymphocytosis^99MRC
Lymphopenia	IS	12007	Lymphopenia	99MRC	12007^Lymphopenia^99MRC
Monocytosis	IS	12008	Monocytosis	99MRC	12008^Monocytosis^99MRC
Eosinophilia	IS	12009	Eosinophilia	99MRC	12009^Eosinophilia^99MRC
Basophilia	IS	12010	Basophilia	99MRC	12010^Basophilia^99MRC
WBC Abnormal	IS	12011	WBC Abnormal	99MRC	12011^WBC Abnormal^99MRC
WBC Left Shift?	IS	17790-7	WBC Left Shift?	LN	17790-7^WBC Left Shift?^LN
Imm Granulocytes?	IS	34165-1	Imm Granulocytes?	LN	34165-1^Imm Granulocytes?^LN
Atypical Lymphs?	IS	15192-8	Atypical Lymphs?	LN	15192-8^Atypical Lymphs?^LN
rstRBC	IS	34525-6	rstRBC	LN	34525-6^rstRBC^LN
Erythrocytosis	IS	12012	Erythrocytosis	99MRC	12012^Erythrocytosis^99MRC
RBC Abnormal distribution	IS	12013	RBC Abnormal distribution	99MRC	12013^RBC Abnormal distribution^99MRC
Anisocytosis	IS	15150-6	Anisocytosis	LN	15150-6^Anisocytosis^LN
Macrocytes	IS	15198-5	Macrocytes	LN	15198-5^Macrocytes^LN
Microcytes	IS	15199-3	Microcytes	LN	15199-3^Microcytes^LN

RBCDual Pop	IS	10379-6	RBCDualPop	LN	10379-6^RBC Dual Pop^LN
Anemia	IS	12014	Anemia	99MRC	12014^Anemia^99 MRC
Hypochromia	IS	15180-3	Hypochromia	LN	15180-3^Hypochromia^LN
HGB Interfere	IS	12015	HGB Interfere	99MRC	12015^HGB Interfere^99MRC
PLT Abnormal Distribution	IS	12016	PLT Abnormal Distribution	99MRC	12016^PLT Abnormal Distribution^99 MRC
Thrombocytosis	IS	12017	Thrombocytosis	99MRC	12017^Thrombocytosis^99MRC
Thrombopenia	IS	12018	Thrombopenia	99MRC	12018^Thrombopenia^99MRC
Platelet Clump?	IS	7796-6	Platelet Clump?	LN	7796-6^Platelet Clump?^LN

Table 11 Communication Parameter Unit

Parameter Unit appear on Software	Communication Parameter Unit
10^12/L	10*12/L
10^9/L	10*9/L
10^6/uL	10*6/uL
10^4/uL	10*4/uL
10^3/uL	10*3/uL
10^2/uL	10*2/uL
mL/L	mL/L
/nL	/nL
/pL	/pL
g/L	g/L
g/dL	g/dL
L/L	L/L
mmol/L	mmol/L
%	%
fL	fL
um^3	um3
pg	pg
fmol	fmol
amol	amol
Age (age unit)	yr

Month (age unit)	mo
Day (age unit)	d
Hour (age unit)	hr

3.

Some OBX data item use custom Enumerated value, each value meanings see below:

Data Item	Enum value
(Blood Mode)	Select Value below: —W - whole blood —P
(Test Mode)	Select Value below: —CBC —CBC+DIFF
(Qc Level)	Select Value below: —L - Low —M
Histogram Adjust and alert	OBX-2type —IS , Select Value below: —T - True —F - False

4.

Histogram Data: as per software setting, the Histogram data transfer is as bellowing:

- (1) No data transferred .
- (2) Data transferred as Bitmap format.

OBX message data type value as —ED|, field value as ^Image^BMP^Base64^, —image| means transferred data is image, —BMP| is data type, means transferred data is BMP type, —Base64| means bmp data's coding format.

- (3) Transfer binary histogram data

OBX message data type value as —ED|, field value as—^Application^Octet-stream^Base64^, histogram data, in which, —Application^Octer-stream| is HL7 standard data subtype, it means application defined binary data type, —Base64| means data coding format.

Note: Transfer bmp data or binary data, is subject to ID filed message in OBX message.

5.Scatter data

Transfer bmp data OBX message data type filed is —ED|, bit filed value as —^Image^BMP^Base64^.....Scatter data.....|, —Image^BMP^Base64| means BMP type data is transferred through Base64 Code.

6. Age Communication:

Patients age is communicated as OBX message, contains a integer and age unit. In IPU software, when age appear —<1|, then the age value communicated as 0.

C.6 Appendix: Base 64 Code Procedure

1. Select 3 neighboring binary (24bit) from left to right, divide as 4 piece 6-bit group, and get ASCII unicode according table 12. As below:

Raw Data	15H	A3H		4BH
Binary data	00010101	10100011		01001011
6-bit group	000101	011010 001101		001011
Code value	5H	1AH	0DH	0BH
unicode	F	a	N	L

Table 11 Base64 Mapping table

Value/Code	Value/Code	Value/Code	Value/Code
0 A	17 R	34 I	51 z
1 B	18 S	35 j	52 0
2 C	19 T	36 k	53 1
3 D	20 U	37 l	54 2
4 E	21 V	38 m	55 3
5 F	22 W	39 n	56 4
6 G	23 X	40 o	57 5
7 H	24 Y	41 p	58 6
8 I	25 Z	42 q	59 7
9 J	26 a	43 r	60 8
10 K	27 b	44 s	61 9
11 L	28 c	45 t	62 +
12 M	29 d	46 u	63 /
13 N	30 e	47 v	
14 O	31 f	48 w	(pad) =
15 P	32 g	49 x	
16 Q	33 h	50 y	

2. Repeat step1 until data flow code finished.

If last data not enough for 3 bytes, and fill in —0|| at the right side, if 6-bit group is made up by filling, then mapping to —=|| Unicode. Then we know when last Unicode in data, then code string have two —=||, when last 2 Unicode in data, and the coding string has one —=|| Unicode.

Below is the example of the two situations:

①Raw Data	0AH			
	00001010			
Filled Data Value	00001010	00000000	00000000	划分
6-bit group	000010	100000	000000	000000
6-bit group				
Matched Data valu	02H	20H	00H	00H
Matched Unicode	C	g	=	=

Appendix D Toxic and Hazardous Substances and Elements

Part Name		Toxic and Hazardous Substances and Elements					
		Lead (bp)	Mercury (HZ)	Cadmium (Cq)	Hexavalent Chromium (CL(^I))	Polybrominated biphenyls (bBB)	Polybrominated diphenyl ethers (bBDE)
Instrument	Shell	○	○	○	○	○	○
	bCBV	×(1)	○	○	○	○	○
	Stamping Parts	○	○	○	×(2)	○	○
	Machining Parts	○	○	○	○	○	○
	Plastic Parts	○	○	○	○	○	○
	Ceramic Parts	○	○	○	○	○	○
	Hardware	○	○	○	○	○	○
	Cables	○	○	○	○	○	○
	Water flow	○	○	○	○	○	○
Accessories	Label	○	○	○	○	○	○
	Cap	○	○	○	○	○	○
	Tools	○	○	○	○	○	○
	Swab	○	○	○	○	○	○
	Height setter	○	○	○	○	○	○
Package	Packing	○	○	○	○	○	○
<p>○: This toxic and hazardous substance or element if contained in any or all of the homogeneous materials for this part is below the limit requirement in SJ/T11363--2006.</p> <p>×: This toxic and hazardous substance or element contained in at least one of the homogeneous materials used for this part is above the limit requirement in SJ/T11363--2006.</p> <p>(1)Some parts on PCB contain Lead, and use lead solder during processing.</p> <p>(2)Use Hexavalent Chromium on coating during sheet working.</p>							

P/N:046-001571-00 (3.0)

Appendix D Automatic Sampler

Automatic sampling device for the purchase, such as no choice can be ignored the following.

Please read the previous chapter, and be familiar with the software interface and operation of the main engine.

A 1 Summary

Automatic sampling device to replace the manual operation of the sample equipment, with automatic recording of test tube rack information, automatic scanning tube bar code number, automatic mixing sample, puncture test tube to absorb blood quantitative transmission to the host for analysis.

In order to ensure the autosampler can work normally suck, ensure the tube output of more than 2ml. Automatic sampler volume is about 150 μ L and transferred to the host with analysis of the effective volume is about 10 μ L, analysis speed depending on the host, can be more than 90 samples per hour, one can put full tube clip 5. If the sample size is larger than 5 test tube stand (50), in the final test tube of the last sample can be added to the test tube, and each finished fifth test tube rack must be removed before the test tube holder.

The automatic sampling device has the function of pause / emergency, that is to analyze the current test tube rack sample can be suspended / emergency key to pause the current analysis, after the host test can be switched to manual sampling mode priority analysis of emergency sample, analysis of the emergency sample and then withdraw from the emergency mode, switch back to the sample to continue to analyze the sample.

After the sample testing, the automatic sampling device is out of the last test tube rack, and the pipeline is flushed.

A 2 Appearance and description

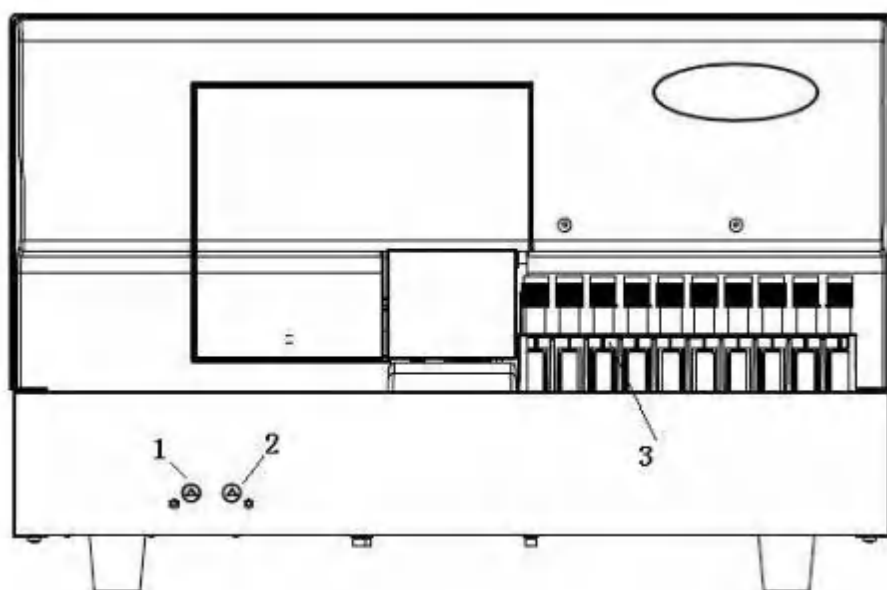

Frontal view

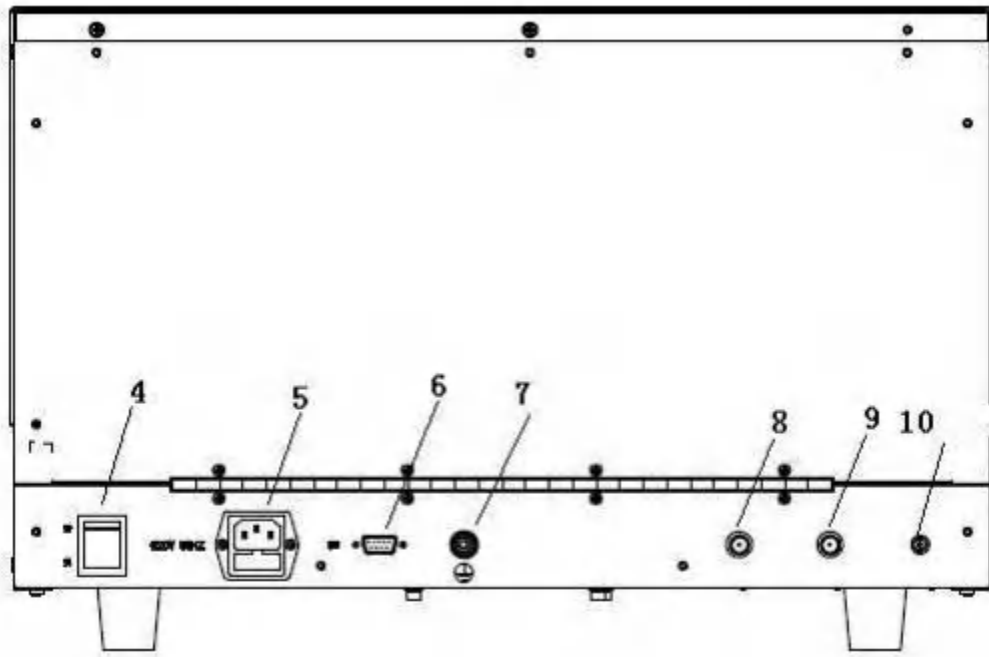

Back View

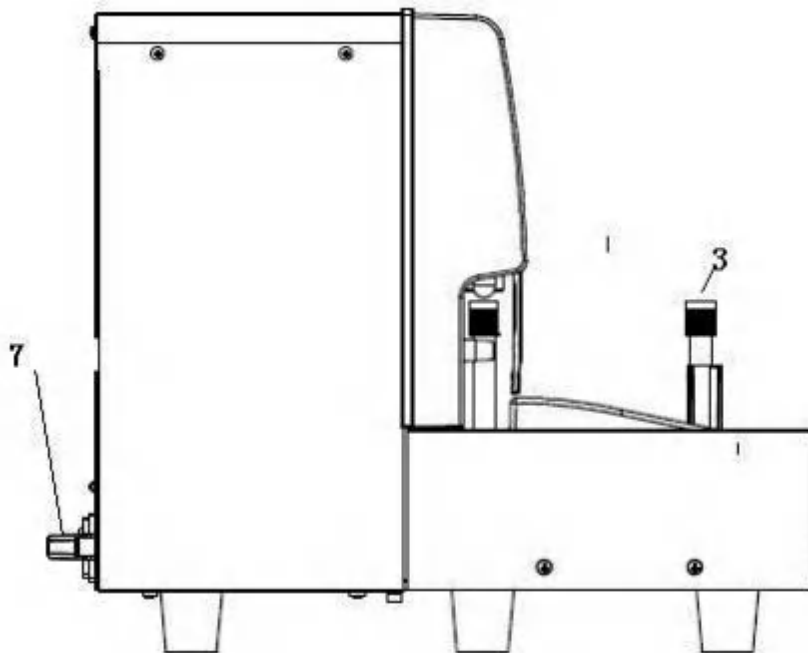

The side view

- 1 —— Start button
- 2 —— Emergency/pause button
- 3 —— Test tube holder
- 4 —— Power switch
- 5 —— Power cord
- 6 —— Serial port
- 7 —— Earthing terminal
- 8 —— Diluent link
- 9 —— Waste link
- 10 —— Sample transport link

A3 Installation

With the host installation conditions , See the fourth chapter in detail.

After opening the package sample will automatically on the host right side close to the host.

Connect the power cord, diluent liquid pipeline, good hosts connected by cable, transfer line and automatic sampler.

A4 Use and maintenance

A4.1 Reagent guide

- 1 、 To guide the host reagent, see 2.4.4 1, 2 points.
- 2、 Click on the "main menu" care and maintenance "reagent guide and maintenance"
- 3 、 Choose "care and maintenance" in the "automatic sampler guide", click on the "mission".

A4.2 Operation

A4.2.1 General operation

Software interface in operating 2.4.

- 1 、 Put on automatic sampler test tube rack, ensure the test tube rack card slot card into the right panel.
- 2 、 n the "switch" select "automatic sampler" mode.

Attention

- 1、 Mode switch must be in place before test tube rack, guarantee the test tube rack card slot card into the right panel, and the direction to correct, otherwise it will lead to mechanical failure。
- 2、 Tube to continuously in a test tube rack, test tube rack can't we have seats, otherwise it will cause downtime and waste in the process of test reagents。
- 3、 As additional sample test process, also want to meet before 2 PM。

3、 click "ok" automatic sampler initialization of former three samples scan, for the first sample blending, the automatic sampler "start" indicator light green light.

4、 Mode dialog disappear after switch, press the "start" key automatic sampler began to work。

5、 if additional sample, please at the end of the last test tube rack completed before a test-tube scans the bar code to add test tube rack, fill the vacancy。

6、 Test tube rack samples after the test, the prompt "test tube rack test done" out of the last test tube rack at the same time washing line, and then enter standby mode。

A4.2.2 Emergency Model

Emergency means put the sample that badly in need of testing in the testing cup under automatic sampler mode, suspend system, switch to the manual test mode for testing, after manual test then switch back to —automatic mode and continue.

Each sample period has time window —emergency/suspend light turns to orange, TEK8530, TEK8510 are 6 seconds, TEK8520 is 3 seconds, press the button —emergency/suspend during the time can stop working, get into emergency mode after the host complete the piercing sample test.

If no pressing button of —emergency/suspend during the light turns on, it will continue next sample test.

1. When the button —emergency/suspend turns on , press it , after the light turns off , the —start button turns green, then automatic sampler suspended, the host test piercing sample.

2. After piercing sample test, the "switch" interface pop-up.

3. Choose —whole blood-continues or other manual test mode, click —ok, after the host initialization completed, then the manual test emergency start.

4. After emergency sample test completed, click —Exit emergency‖, —mode switch‖ interface pop-up, choose —automatic sample‖ mode.

5. After the host initialized and the —mode switch‖ interface disappeared , press —start‖ button, when —start‖ light turns off, System continues to test automatic sampler unfinished samples.

A4.3 Fault handling

IF downtime because of fault, after fault handling, removes the test tube rack and enter —automatic sample‖ mode to test.

If you can't make sure whether can troubleshoot problems ,pls contact with our engineer

If there is a red alarm prompt in the bottom right corner of software during the testing,in the same time machine also have beeping,pls return to main interface and click on —Exit — Button,exit program

Enter into program,if there is yellow prompt (—communication error, open serial ports failed —),pls open Windows task manager,after closed —TEK85xx.exe‖, re-entered software,‖xx‖ must be according to machine's model number.

Re-entered software interface,click on — Exit model .According to different phenomena to do following operation;

A4.3.1 Test-tube holder haven't clamped test-tube

- 1 、 Take out current test-tube holder position's corresponding test-tube.
- 2 、 Click on main menu‖ repairing & maintenanc‖---->‖Reagent Guide & Maintenc‖ .
- 3 、 Click on —Repairing & maintenanc‖---->‖Auto-sampler reset‖---->‖Task execution‖ .
- 4 、 Take out test-tube shelf and put test-tube back into original position.

A4.3.2 Test-tube holder have clamped test-tube

- 1 、 Click on main menu —Repairing & Maintenance — ---->Reagent Guide & Maintenc‖ .
- 2 、 Click on —Repairing & maintenanc‖---->‖Auto-sampler reset‖---->‖Task execution‖ .
- 3 、 Take test-tube shelf out.

A4.3.3 Prompt continuous testing result is abnormal

- 1 、 Checking if test-tube shelf existed the phenomena which have continuous above 2pcs empty position.

2 、 Checking if continuous 2pcs test-tube's blood volumes are less than 2mL after problems were corrected,Above 3 kinds problems can keep continuing testing .if after corrected,the fault still existed,pls contact with your company. In order to make sure testing result's accuracy, pls refer to machine's worklist,Once testing result is abnormal, the rest samples must re-test.
